

 **TADANO**



SNAKE 20
on Iveco Daily - 35S14H



Snake 20 on Iveco Daily - 35S14H

Truck-mounted aerial work platform

WORKING AREA

Front outrigger beams both extended

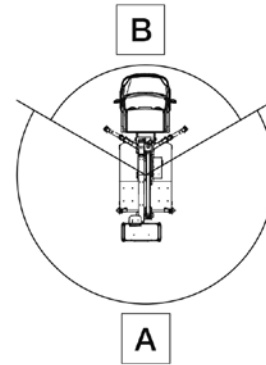
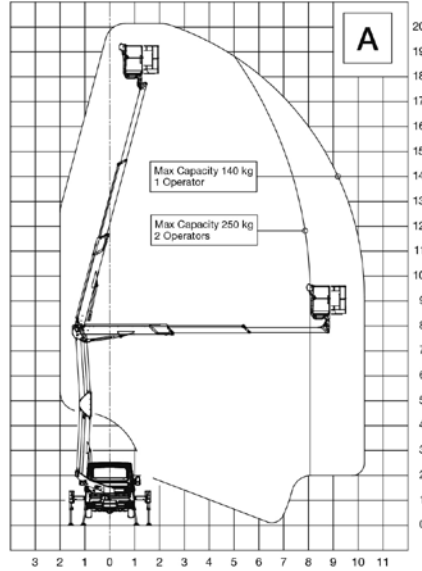
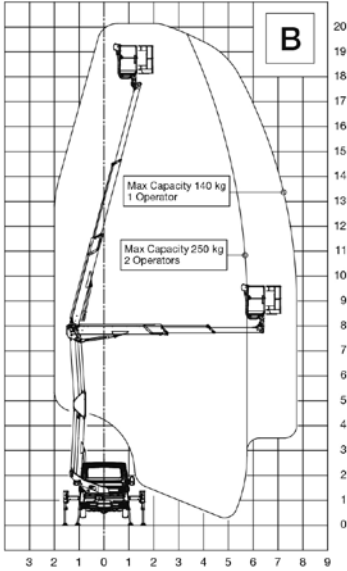

Front outrigger beams one extended and one retracted

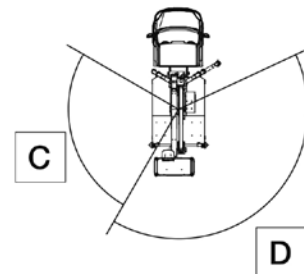
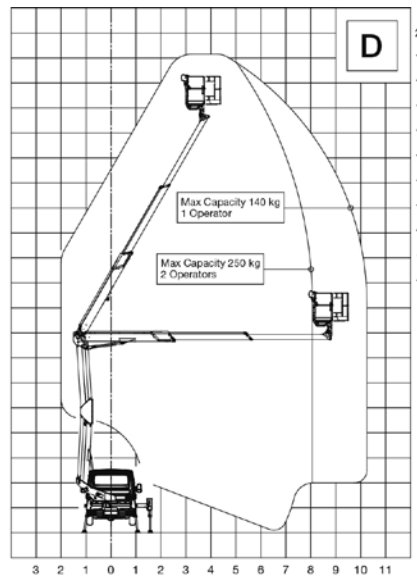
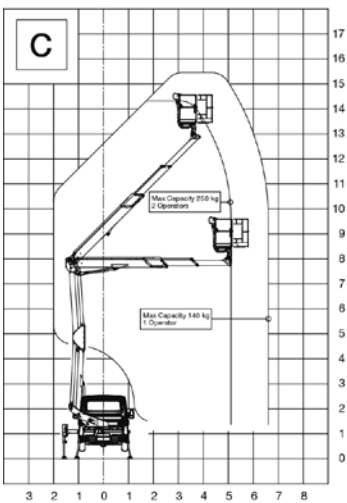

Front outrigger beams both retracted

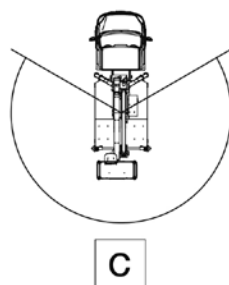
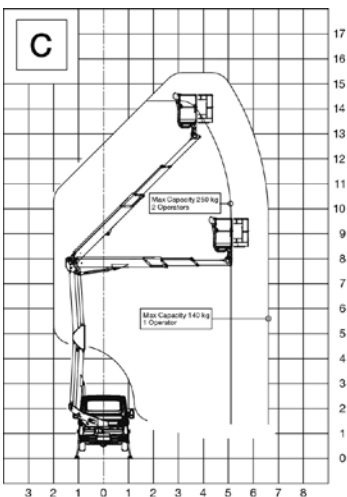

TECHNICAL DRAWINGS

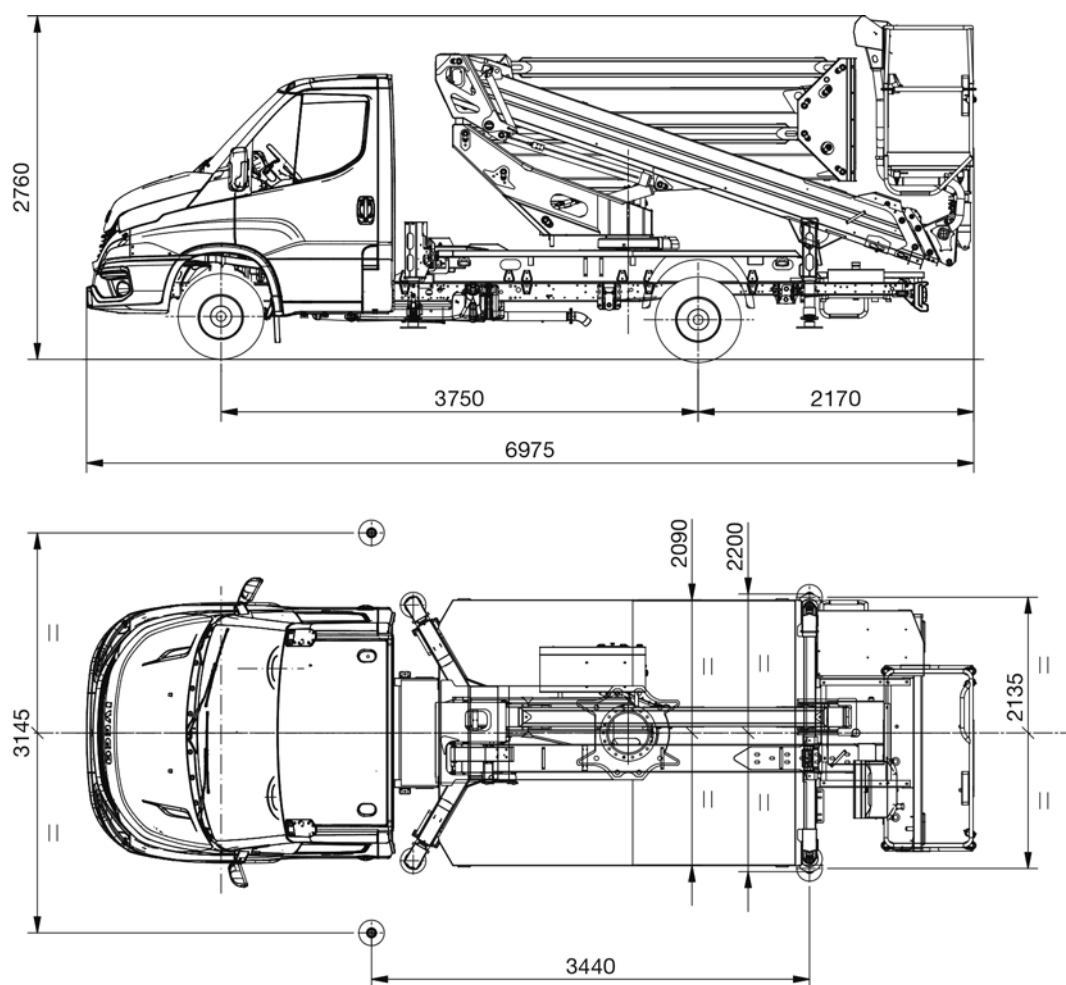

SPECIFICATIONS

Max working height	20.0 m
Max outreach	10.2 m
Max capacity	250 kg
Basket (materials and dimensions)	Alu 1.4 x 1.1 x 0.7 m
Controls	Electro-hydraulic platform controls, hydraulic outriggers
Turret rotation	400°
Basket rotation	+/- 90°
Outriggers	HE - H
Machine length	6975 mm
Machine height	2760 mm
Machine width	2200 mm

STANDARD EQUIPMENT

Truck

Iveco Daily 35S14H MY24, wheelbase 3750 mm – GVWR 3.5 t

136 HP (100 kW) Euro VIE HD engine

6-speed mechanical gearbox

Single rear wheels

40 L diesel fuel tank

Intelligent Speed Assistance (ISA)

Driver drowsiness and alertness warning (DDAW + ADDW)

Tyre Pressure Monitoring System (TPMS)

Active Lane Keeping Assist

Start & Stop

Automatic wiper and low beam headlight control

Electric parking brake

Comfort TFT display panel

Rear parking sensors

Driver and passenger airbag

Tyres 235/65 R16

Aerial Work Platform

Electric PTO engagement with automatic disengagement

Audible warning when PTO is engaged and parking brake released

PTO hour meter mounted on the vehicle dashboard

Cab hour meter indicator lights displaying PTO engaged status and outriggers out of overall width

Main engine (and optional auxiliary engine) start/stop from basket and turret

Emergency stop button with engine shutdown in basket and turret

Single-phase 220/110V AC power socket on basket with RCBO

Electro-hydraulic controls for platform control functions

Hydraulic controls for outriggers

Hydraulic extension of outrigger beams

Outrigger beam extension/retraction lock with outriggers deployed

Push-button panel with levers in basket

Emergency push-button panel for platform control functions located on the vehicle deck

Load moment monitoring and limiting system

Boom angle/telescopic extension limitation system

Homing function and memory function

Anti-collision system for extendable structure, cab and chassis

Variable stabilization (front beams: extended, retracted; one extended and one retracted)

Manual pump for emergency lowering

Emergency stop button bypass

Outrigger plastic pads Ø 200 mm

Hoses and cables routed inside the boom

Access ladder to basket

Aluminium basket 1400 x 1100 x 700 mm, max occupancy: 2 persons

Basket hydraulic rotation 90° right – 90° left with rotary actuator

Metal protective covers for turret and basket controls

Thermal protection for the electrical system

Load-holding valves on all cylinders

Pressure relief valve in hydraulic circuit

Anti-slip aluminium floor

Corrosion protection for structural components and stainless steel fasteners

White and blue standard paint (RAL 9016 white – RAL 5002 blue)

OPTIONAL

Truck

Non-standard cab paint finish

Comfort Pack (manual air conditioning, 7" radio with Bluetooth and steering wheel controls, fog lights, cruise control, seat with lumbar support and armrest)

All-season tyres

Electrically adjustable and heated external rear-view mirrors

Aerial Work Platform

Fiberglass basket 1400 x 700 x 1100 mm (replacing the standard basket)

Fiberglass basket 1400 x 700 x 1100 mm, with 1 kV dielectric resistance (replacing the standard basket)

Fiberglass basket with door 1400 x 700 x 1100 mm, according to STBT200 standard (replacing the standard basket)

Basket control panel with levers and 4" display

Electro-hydraulic controls for outriggers and beams – automatic stabilization from basket

Automatic stabilization from ground (only available with electro-hydraulic outrigger controls)

7" touchscreen display on turret with protective cover (only available with electro-hydraulic outrigger controls)

Stabilizer jacks with increased stroke (replacing the standard component)

Multipurpose air/water line on basket

Oil tank protection

Set of 4 nylon outrigger mats

Outrigger mat holder kit, suitable for 300 x 300 x 40 mm mats

Safety belt kit, 2 pieces

Debris protection kit

12 V DC power socket on basket

12 V DC power socket + LED work light on basket

USB charging port on basket (only available with aluminium basket)

12 V DC emergency lowering electric pump – 1.6 kW

Single-phase auxiliary electric pump (220 V AC – 2.2 kW), including electric panel and battery charger powered from external mains

Single-phase auxiliary electric pump (110 V AC – 2.2 kW), including electric panel and battery charger powered from external mains

12 V yellow magnetic rotating beacon for truck cab

12 V blue magnetic rotating beacon for truck cab

2 x 12 V yellow rotating beacon for truck cab + bar

2 x 12 V yellow rotating beacon for truck cab + bar + warning triangle

Parking wheel chocks

Plastic tool box (480 x 400 x 400 mm)

Stainless steel tool box (500 x 350 x 350 mm)

2 x Stainless steel tool box (500 x 350 x 350 mm)

Bicycle carrier bars

White-red reflective marking

Fixed sides, 150/200 mm high, on vehicle deck

Single drop-side, 150/200 mm high, on vehicle deck

Two drop-sides, 150/200 mm high, on vehicle deck

Non-standard platform paint finish

Customer-specific decals

Remote connectivity kit (5 year subscription)

www.tadano.com

Tadano Ltd.

Kanda Square 18th Floor, 2-2-1 Kanda-Nishikicho, Chiyoda-ku, Tokyo 101-0054, Japan
Phone: +81-3-6811-7309 (international Division)

PM OIL & STEEL S.P.A.

Via G. Verdi, 22 - 41018 - San Cesario sul Panaro (Modena) - Italy

