

PM 48523 SP C

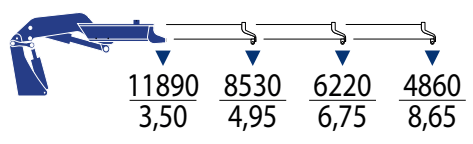

Lifting Capacity

Portata Macchina Base • Tragfähigkeit • Capacité de levage • Capacidad de elevación



t m	m	l/min	MPa	°	kg	mm	mm	mm
42,2	8,80	80+100	32,0	∞	4530	2550	2500	1325

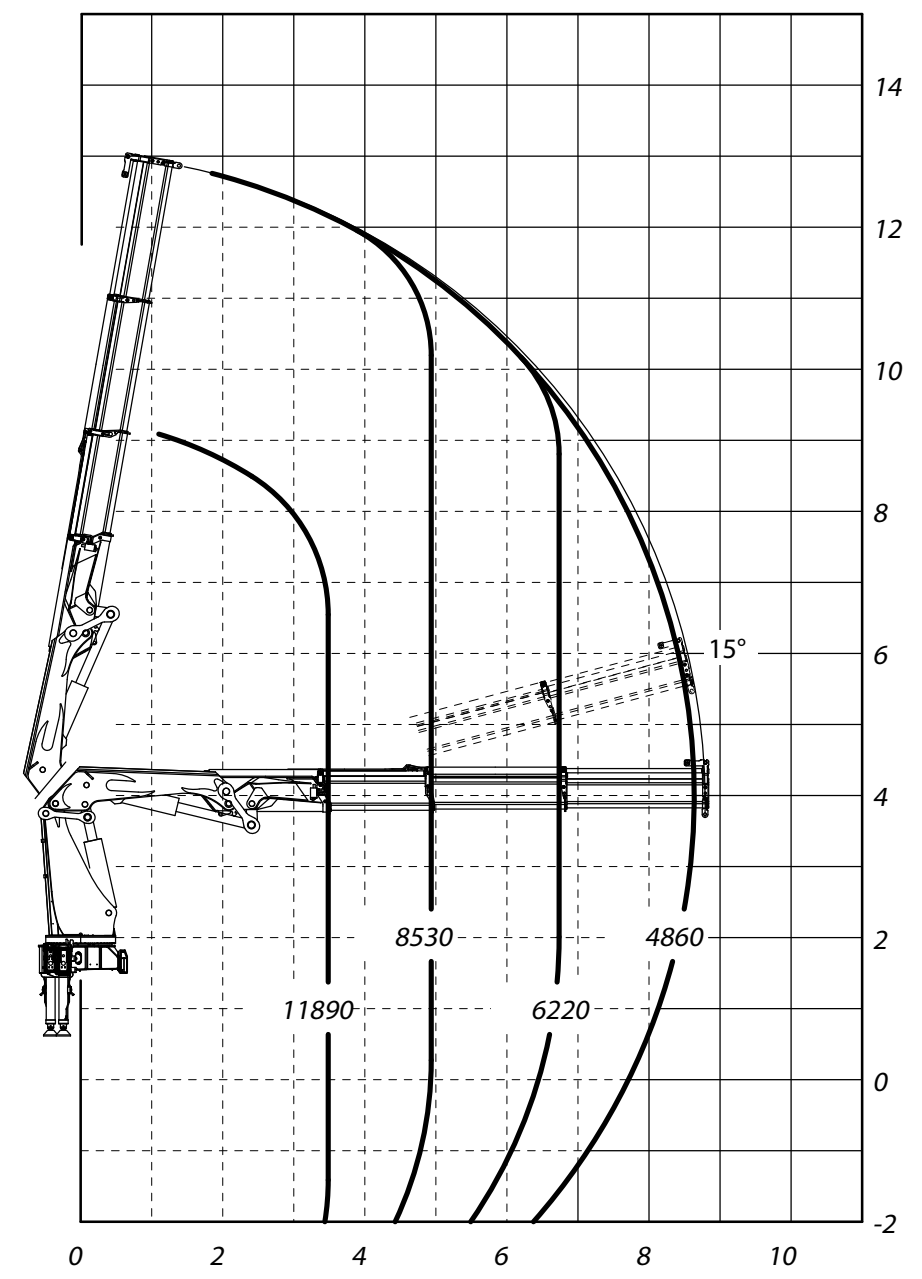

All technical data, descriptions and illustrations are purely indicative and subject to change without notice. • Tutti i dati tecnici, le descrizioni e le illustrazioni sono puramente indicativi e soggetti a modifiche senza preavviso. • Alle technischen Daten, Beschreibungen und Abbildungen sind unverbindlich und können ohne vorherige Ankündigung geändert werden. • Todos los datos técnicos, descripciones e ilustraciones son meramente indicativos y están sujetos a cambios sin previo aviso. • Toutes les données techniques, descriptions et illustrations sont purement indicatives et susceptibles d'être modifiées sans préavis.

PM 48523 SP C



www.tadano.com

Tadano Ltd.

Kanda Square 18th Floor, 2-2-1 Kanda-Nishikicho, Chiyoda-ku, Tokyo 101-0054, Japan
Phone: +81-3-6811-7309 (International Division)

PM OIL & STEEL S.P.A.

Via G. Verdi, 22 - 41018 - San Cesario sul Panaro (Modena) - Italy



Reaching new heights

