

GR-1200XL

120 US TON MAX. CRANE CAPACITY

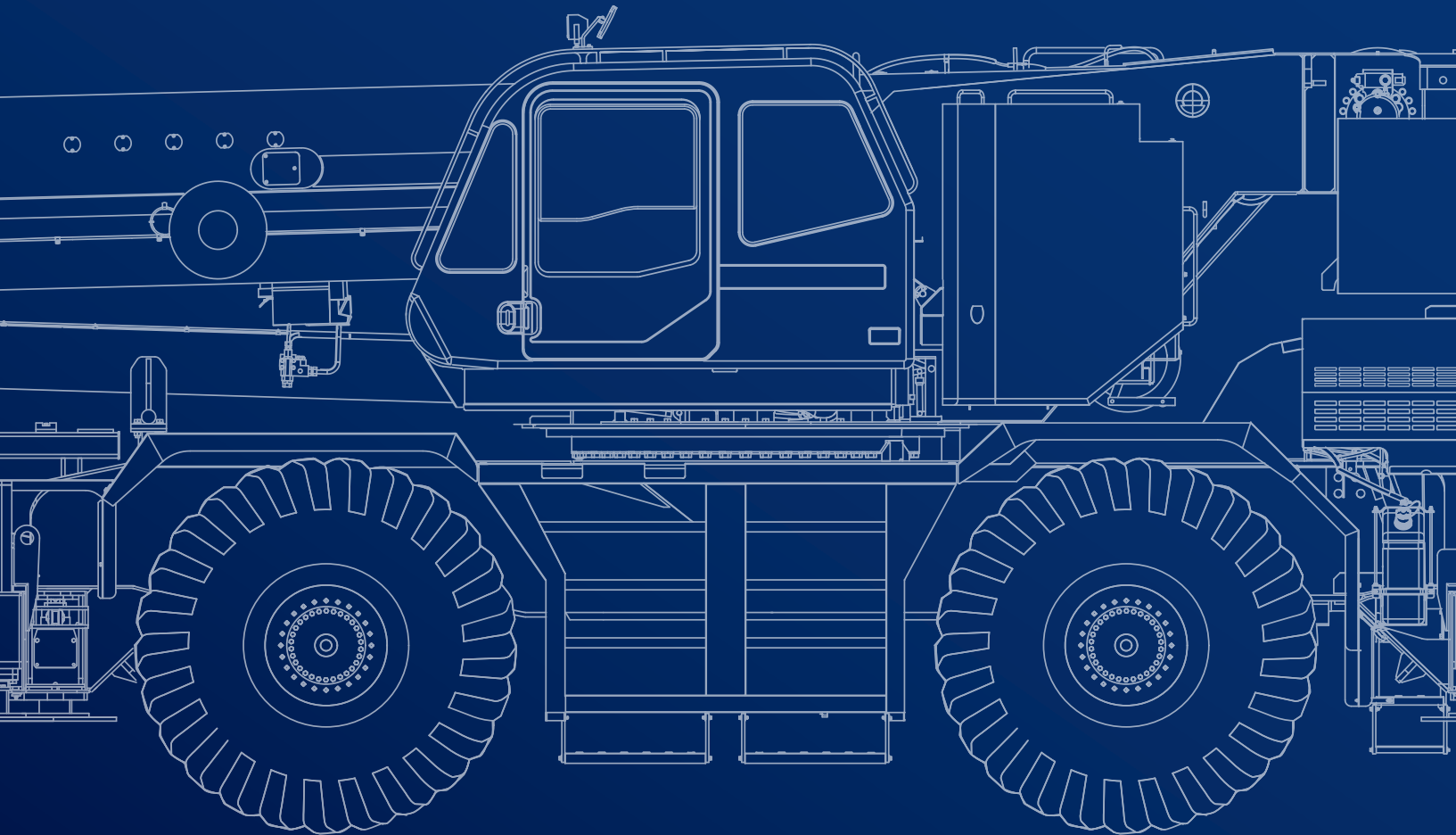

- Suitable for alternative fuels





February 2025. Unless otherwise specified, all information in this brochure refers to a standard crane equipment, and it is intended as general information only. No liability is assumed. Errors reserved. Product specifications and prices are subject to changes without notice. The photographs and/or drawings in this brochure are for illustrative purposes only. For correct and safe crane operation, the original operating manual and lifting capacity charts are essential. Failure to follow the corresponding Operator's Manual when using our equipment or failure to otherwise act responsibly may result in property damage, serious injury or death. The sole warranty applicable with respect to our equipment is the standard warranty as per general terms and conditions of sales and service (ask your local Tadano dealer for details), and Tadano makes no other warranty, express or implied. All rights reserved. Any use of the trademarks, logos, brand names and model names used herein is prohibited.

© Tadano Ltd. 2025

Contents

Specifications	5
Vehicle dimensions	6-7
General dimensions	7
Off-road driving	9
Axle weight distribution chart	10
Speeds and gradeability	10
Steering	10
Operation	11
Main boom	12
Slewing	12
Hoist	12
Line speeds and pulls	13
Drum wire rope capacities	13
Drum dimensions	13
MB: Main boom	14-21
FJ: Folding swing-away jib	22-24
Notes to Lifting Capacity	26-27
Warning and Operating Instructions for on Rubber Lifting Capacities	27
Notes for Load Moment Indicator (AML-C)	28
Technical Description	29
Crane specifications	30-31
Carrier specifications	31
Standard equipment	32-33
Optional equipment	33

Key

	Counterweight		Rope diameter
	Lifting capacities on outriggers · 360°		Rope length
	Radius		Hook block
	Main boom		Number of lines
	Main boom length		Number of sheaves in hook block
	Folding swing-away jib		Line pulls available
	Free on wheels		Possible load of hook block
	Tires		Weight of hook block
	Hook block		Distance head sheave axle – hook ground
	Hoist		Max. outrigger load
	Travel speed		Length of stroke (support cylinders)
	Gradeability		Base machine
	Working speeds		Gross vehicle weight
	Rope		Weight on front axle
	Jib		Weight on rear axle
	Boom telescoping		Wire rope layer
	Boom elevation		Total wire rope
	Slewing		Smart Chart: Smart crane control system for main boom and rooster sheave operation enabling higher lifting capacities especially over outriggers. Enables safe use of the full capacity of the crane even in asymmetric outrigger configurations. Visualization of full working area in operator cabin. In-cab lift simulation.
	Max. line pull		

SPECIFICATIONS

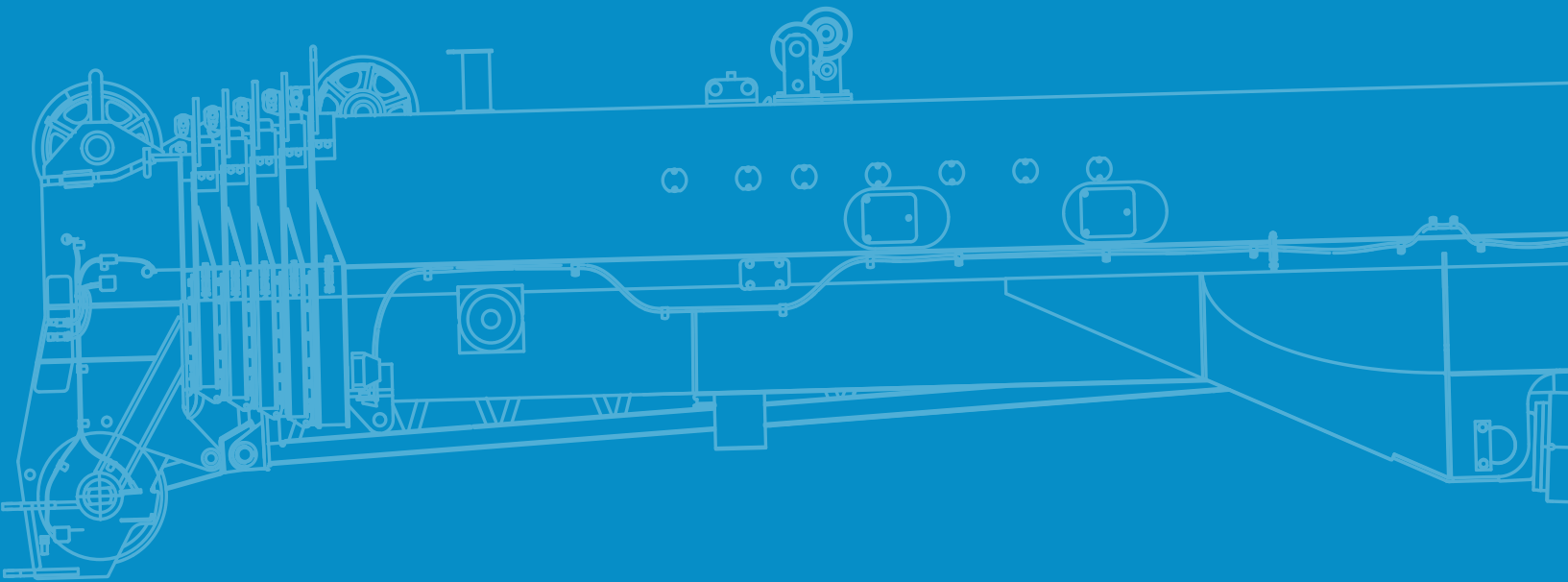

Specifications

Vehicle dimensions

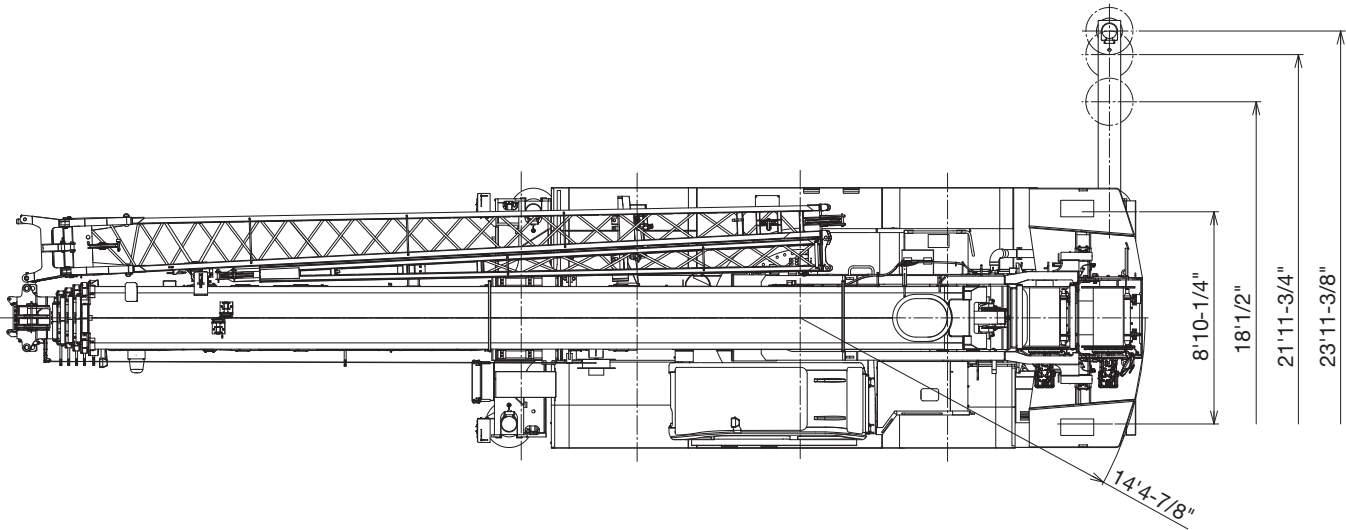
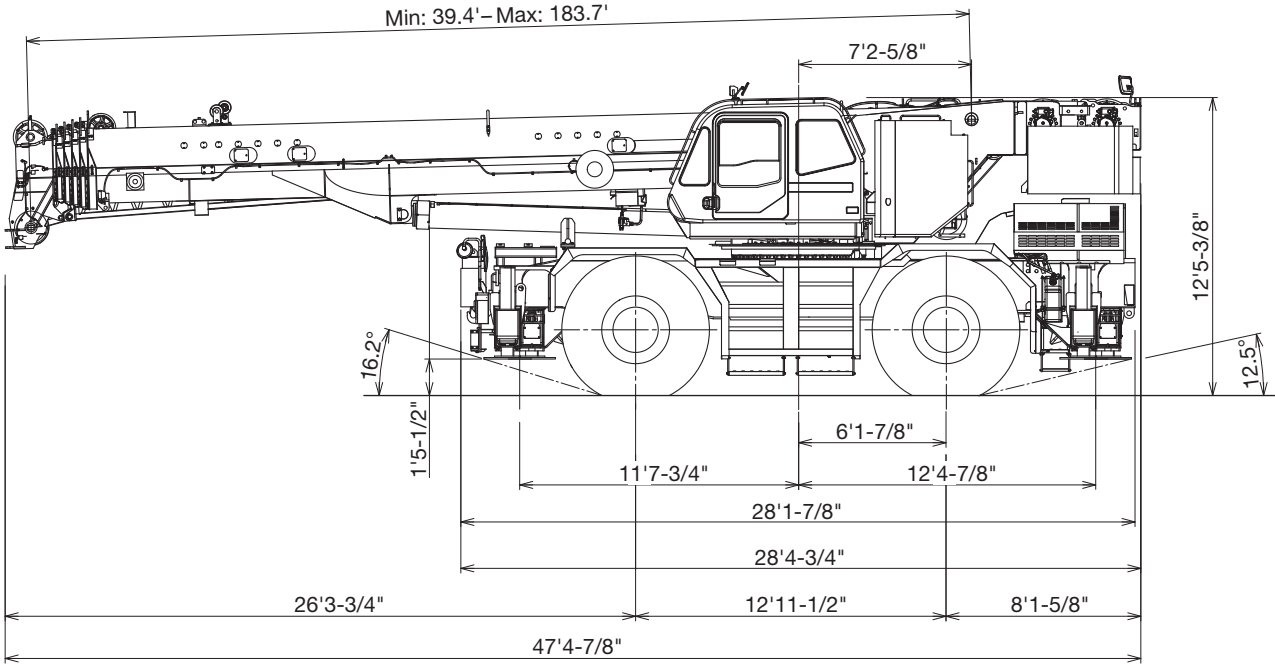

Dimension is with boom angle at -1.5 degree.

Specifications

Vehicle dimensions

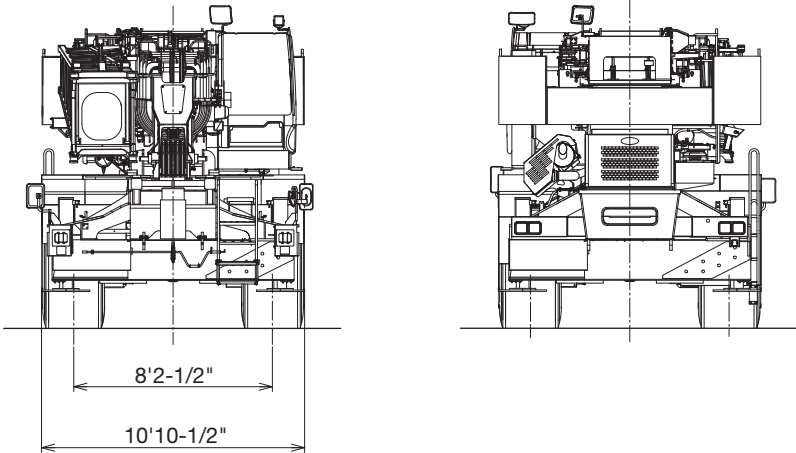

General dimensions







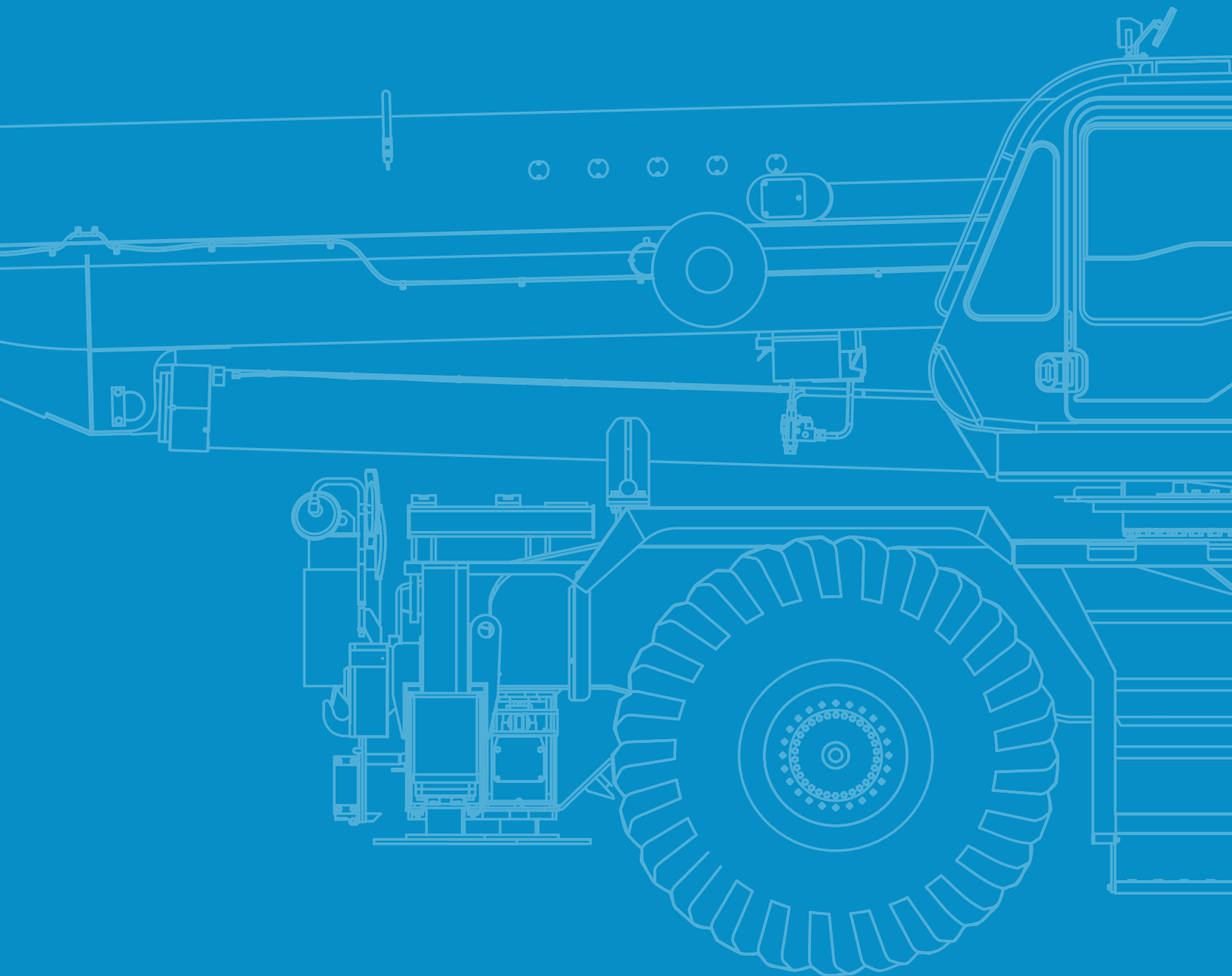

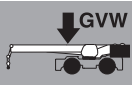
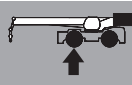

Overall length	approx. 47' 4-7/8"
Overall width	approx. 10' 10-1/2"
Overall height	approx. 12' 5"-3/8"
Carrier length for traveling	approx. 28' 1-7/8"
4 wheel steer*	22' 4"
2 wheel steer*	39' 1"

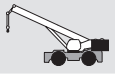

* Turning radius (29.5-25 34PR (OR))



TECHNICAL DATA FOR OFF-ROAD DRIVING

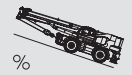

Off-road driving

Axle weight distribution chart			
			
	122,554 lb	61,156 lb	61,398 lb
Remove:			
 7.9 ton	-661 lb	-1,007 lb	346 lb
 120 ton	-2,381 lb	-4,596 lb	2,215 lb
 Top jib	-736 lb	-989 lb	252 lb
 Base jib	-1,889 lb	-3,741 lb	1,852 lb
Auxiliary lifting sheave	-129 lb	-385 lb	256 lb
 Counterweight	-22,046 lb	9,628 lb	-31,674 lb
Auxiliary winch and wire rope	-2,272 lb	1,022 lb	-3,295 lb
Add:			
 77 ton	1,500 lb	2,896 lb	-1,396 lb
 50 ton	1,336 lb	2,579 lb	-1,243 lb

Speeds and gradeability	
	29.5–25 34PR (OR)
	84 % at stall 57 % Machine should be operated within the limit of engine crankcase design (30°: Cummins QSB6.7 EPA Tier4 Final)
	12 mph

Steering	
	4 wheel steer
	2 wheel steer



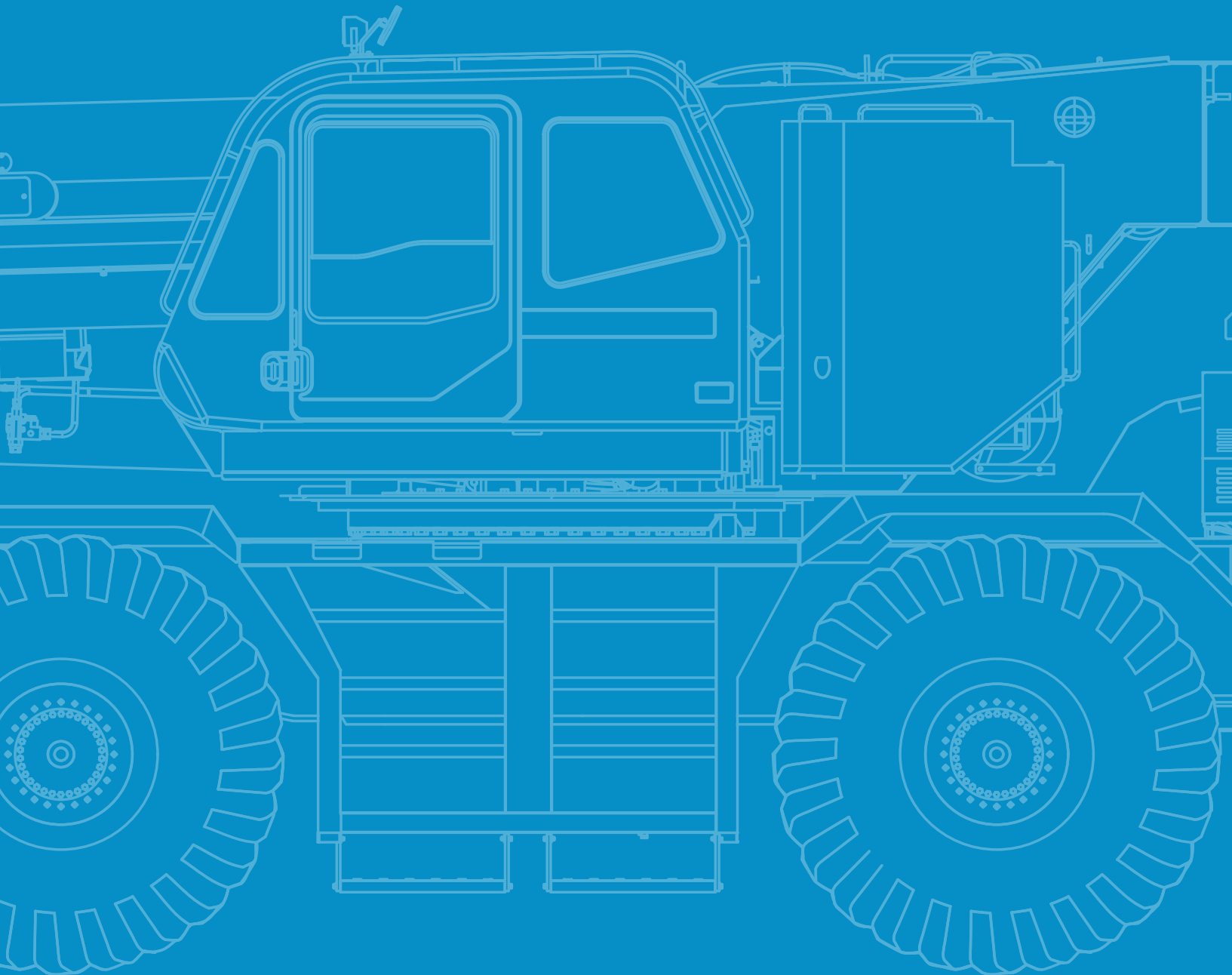

TECHNICAL DATA FOR OPERATION



Operation

Main boom			
	39.4 ft - 183.7 ft		-1.5° - 81° approx. 40 s (20° - 60°)





Slewing	
	1.5 min ⁻¹

Hoist			
			
	15,900 lb	3/4"	984'
	15,900 lb	3/4"	518'

Operation

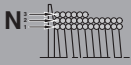
Line speeds and pulls

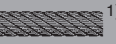
Main or auxiliary winch - 15" drum



 N	  low high		 low
	low	high	low
1	253 ft/min.	354 ft/min.	21,800 lb
2	276 ft/min.	384 ft/min.	19,900 lb
3	299 ft/min.	413 ft/min.	18,200 lb
4	318 ft/min.	446 ft/min.	16,800 lb
5	341 ft/min.	476 ft/min.	15,600 lb
6	361 ft/min.	505 ft/min.	14,600 lb
7 ³⁾	384 ft/min.	535 ft/min.	13,700 lb

Maximum permissible line pull wire strength 15,900 lb with 7 x 35 class rope.

- 1) Line speed based only on hook block, not loaded.
- 2) Developed by machinery with each layer of wire rope, but not based on rope strength or other limitations in machinery or equipment.
- 3) Seventh layer of wire rope are not recommended for hoisting operations.

Drum wire rope capacities

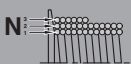
Main and auxiliary drum grooved lagging 3/4" wire rope

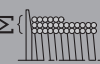
 N		 Σ
1	147.0 ft	147.0 ft
2	159.4 ft	306.4 ft
3	172.2 ft	478.7 ft
4	184.7 ft	663.4 ft
5	197.2 ft	860.6 ft
6	209.6 ft	1070.2 ft
7	222.1 ft	1292.3 ft

Drum dimensions

Root diameter	15"
Length	29-1/4"
Flange diameter	26-5/8"

Fully extended – 360°

22,000 lb		23' 11-3/8" spread										360°			
		39.4'	52.7'	52.7'	66.1'	66.1'	66.1'	66.1'	79.4'	79.4'	79.4'	79.4'	92.8'	92.8'	92.8'
ft	1,000 lb														
8	242,500*	143,300	77,200	-	-	-	-	-	-	-	-	-	-	-	-
10	180,300	143,300	77,200	136,900	110,200	77,200	63,100	-	-	-	-	-	-	-	-
12	159,000	143,300	77,200	127,400	110,200	77,200	57,800	106,300	106,300	77,200	61,100	-	-	-	-
15	133,200	132,700	72,100	115,300	110,200	77,200	51,400	97,000	106,300	77,200	55,100	80,700	69,900	48,100	-
20	101,400	100,500	62,200	97,200	101,400	68,100	43,400	81,800	102,300	71,400	47,400	71,700	69,900	42,500	-
25	78,000	77,200	54,900	76,700	77,800	60,800	37,500	70,500	78,700	64,600	41,700	62,400	65,700	37,900	-
30	60,800	59,700	49,400	58,900	60,600	55,300	33,100	60,000	61,900	59,100	37,300	54,700	60,400	34,000	-
35	-	45,600	45,000	44,800	46,500	50,700	29,500	45,600	47,800	52,900	33,500	47,000	52,500	30,400	-
40	-	35,100	39,900	34,200	35,900	41,400	26,700	35,100	37,300	41,900	30,600	36,400	41,400	27,600	-
45	-	27,800	32,200	26,900	28,700	33,700	24,500	27,800	29,800	34,200	28,200	28,900	33,700	25,400	-
50	-	-	-	21,600	23,100	28,200	22,500	22,300	24,300	28,400	26,000	23,400	28,000	23,400	-
55	-	-	-	17,400	19,000	23,800	20,900	18,100	20,100	24,000	24,300	19,200	23,800	21,600	-
60	-	-	-	-	-	-	-	15,000	16,800	20,700	21,800	15,900	20,300	20,100	-
65	-	-	-	-	-	-	-	12,300	14,100	17,900	19,000	13,200	17,400	18,700	-
70	-	-	-	-	-	-	-	10,100	11,900	15,700	16,800	11,000	15,200	16,800	-
75	-	-	-	-	-	-	-	-	-	-	-	9,300	13,200	15,000	-
80	-	-	-	-	-	-	-	-	-	-	-	7,700	11,700	13,200	-
85	-	-	-	-	-	-	-	-	-	-	-	6,400	10,400	11,900	-
	16	10	6	9	8	6	6	7	7	6	5	6	5	4	
1)	42,100	41,900	44,100	34,000	39,700	44,100	35,100	35,100	39,200	41,000	35,900	35,300	38,100	35,900	
2)	0°	0°	0°	0°	0°	0°	0°	0°	0°	0°	0°	0°	0°	0°	
3)	1	10	1	10	11	2	1	11	12	2	1	12	2	1	
4)	1	24	2	25	26	12	3	27	28	13	4	29	14	5	

Telescopic conditions (%)

1.	0	46	0	92	46	0	0	92	46	0	0	92	0	0
2.	0	0	0	0	46	0	0	46	46	0	0	46	46	0
3.	0	0	0	0	0	0	0	0	46	46	0	46	46	0
4.	0	0	0	0	0	46	0	0	0	46	46	0	46	92
5.	0	0	46	0	0	46	92	0	0	46	92	0	46	92

* Over front with special equipment

- 1) Maximum capacity without boom pin
- 2) Minimum boom angle (°) for indicator length (no load)
- 3) Boom block
- 4) Boom number

NOTE:

The lifting capacity data stored in the LOAD MOMENT INDICATOR (AML-C) is based on the standard number of parts of line listed in the chart.

Fully extended – 360°

22,000 lb		23' 11-3/8" spread										360°					
		106.1'	106.1'	106.1'	119.5'	119.5'	119.5'	132.8'	132.8'	132.8'	146.2'	146.2'	146.2'	159.6'	159.6'	172.9'	183.7'
ft	1,000 lb																
20	60,400	56,200	41,200	-	41,000	-	-	-	-	-	-	-	-	-	-	-	-
25	55,100	56,200	37,700	45,600	41,000	33,100	37,300	31,700	31,100	-	-	-	-	-	-	-	-
30	49,800	56,200	34,400	43,900	41,000	30,200	37,300	31,700	29,100	31,700	27,300	26,500	-	-	-	-	-
35	44,500	51,600	31,100	40,100	39,200	27,300	35,700	30,900	27,100	30,900	26,500	26,000	25,600	23,100	20,700	-	-
40	38,100	40,600	28,200	36,600	36,800	25,100	32,800	28,900	25,100	28,900	24,900	24,500	25,600	23,100	20,700	18,100	-
45	30,400	32,800	26,000	32,000	34,200	22,900	30,000	27,100	23,100	26,900	23,400	23,100	24,300	22,500	20,700	18,100	-
50	24,900	27,300	24,000	26,500	28,400	21,200	26,200	25,400	21,600	24,900	21,800	21,600	22,700	21,400	20,500	18,100	-
55	20,700	22,900	22,300	22,000	24,000	19,600	22,000	23,800	20,100	22,300	20,500	20,300	21,400	20,300	19,600	17,900	-
60	17,400	19,400	20,700	18,500	20,500	18,300	18,500	20,900	19,000	18,700	19,400	19,200	19,400	19,400	18,500	17,000	-
65	14,600	16,800	19,400	15,900	17,600	17,000	15,900	18,100	17,600	16,100	18,300	18,100	16,500	17,900	17,200	16,300	-
70	12,300	14,300	17,200	13,400	15,400	15,900	13,400	15,900	16,800	13,700	15,900	16,100	14,300	15,700	14,800	14,800	-
75	10,400	12,600	15,200	11,700	13,400	15,000	11,500	13,900	14,800	11,900	13,900	14,100	12,300	13,700	12,800	12,800	-
80	8,800	10,800	13,400	9,900	11,700	13,200	9,900	12,100	13,000	10,100	12,300	12,300	10,600	11,900	11,200	11,200	-
85	7,500	9,500	12,100	8,600	10,400	11,700	8,400	10,800	11,500	8,800	10,800	11,000	9,300	10,600	9,700	9,700	-
90	6,200	8,200	10,800	7,300	9,000	10,600	7,300	9,500	10,400	7,500	9,500	9,700	7,900	9,300	8,600	8,600	-
95	5,100	7,100	9,700	6,200	7,900	9,500	6,200	8,400	9,300	6,400	8,400	8,600	6,800	8,200	7,500	7,500	-
100	-	-	-	5,300	7,100	8,400	5,300	7,500	8,200	5,500	7,500	7,700	6,000	7,300	6,400	6,400	-
105	-	-	-	4,600	6,200	7,500	4,400	6,600	7,300	4,600	6,600	6,800	5,100	6,400	5,500	5,500	-
110	-	-	-	3,700	5,500	6,800	3,700	5,700	6,600	3,700	6,000	6,000	4,200	5,500	4,900	4,900	-
115	-	-	-	-	-	-	3,100	5,100	6,000	3,100	5,100	5,300	3,500	4,900	4,200	4,200	-
120	-	-	-	-	-	-	2,400	4,600	5,300	2,600	4,600	4,600	3,100	4,200	3,500	3,500	-
125	-	-	-	-	-	-	2,000	4,200	4,900	2,000	4,000	4,200	2,400	3,700	2,900	2,900	-
130	-	-	-	-	-	-	-	-	-	-	3,500	3,700	2,000	3,100	2,400	2,400	-
135	-	-	-	-	-	-	-	-	-	-	3,100	3,300	-	2,600	2,000	-	-
140	-	-	-	-	-	-	-	-	-	-	-	-	-	2,200	-	-	-
145	-	-	-	-	-	-	-	-	-	-	-	-	-	2,000	-	-	-
	4	4	4	4	4	4	4	4	4	4	4	4	4	4	4	4	4
1)	35,300	38,100	36,800	34,000	34,000	33,100	31,700	30,400	30,600	27,300	27,300	26,500	25,600	23,100	20,700	18,100	-
2)	0°	0°	0°	0°	0°	0°	0°	0°	0°	21°	0°	0°	30°	0°	35°	41°	-
3)	13	2	1	2	3	1	5	4	1	6	7	1	8	1	1	9	-
4)	30	15	6	16	17	7	19	18	8	20	21	9	22	10	11	23	-

Telescopic conditions (%)

	1.	92	46	0	92	46	0	92	46	0	92	46	0	92	46	92	100
	2.	46	46	0	46	46	0	92	46	46	92	46	92	92	92	92	100
	3.	46	46	46	46	46	92	46	46	92	92	92	92	92	92	92	100
	4.	46	46	92	46	46	92	46	92	92	46	92	92	92	92	92	100
	5.	0	46	92	46	92	92	46	92	92	46	92	92	46	92	92	100

- 1) Maximum capacity without boom pin
- 2) Minimum boom angle (°) for indicator length (no load)
- 3) Boom block
- 4) Boom number

NOTE:

The lifting capacity data stored in the LOAD MOMENT INDICATOR (AML-C) is based on the standard number of parts of line listed in the chart.

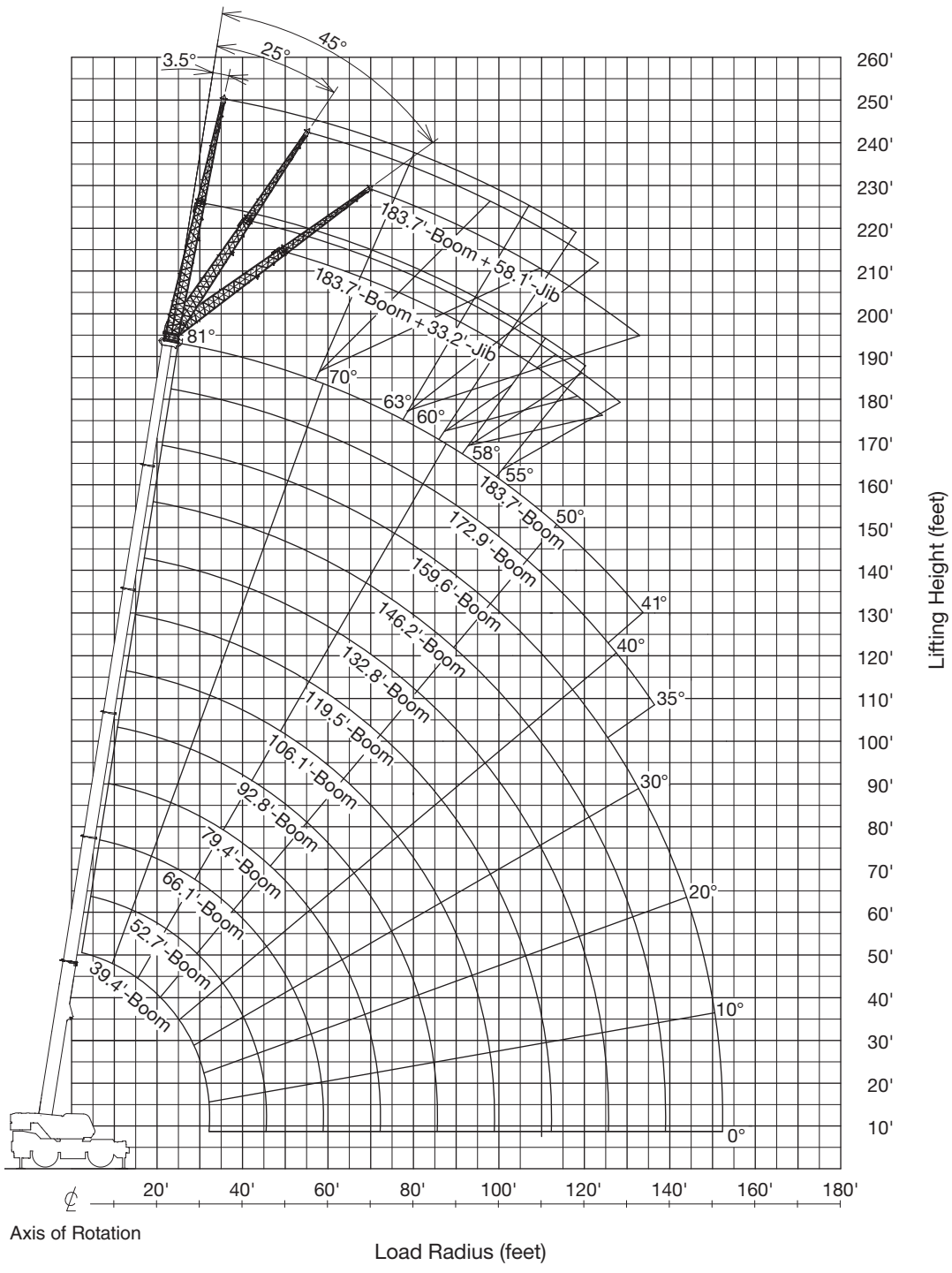

BOOM

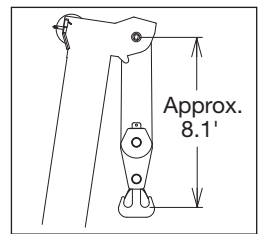

JIB

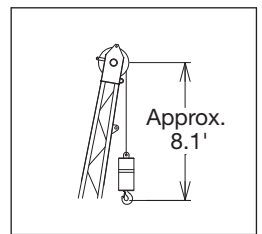

SINGLE TOP

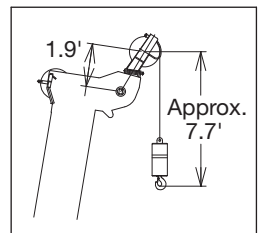

NOTE:
 Boom and jib geometry shown are for unloaded condition and machine standing level on firm supporting surface.
 Boom deflection and subsequent radius and boom angle change must be accounted for when applying load to hook.

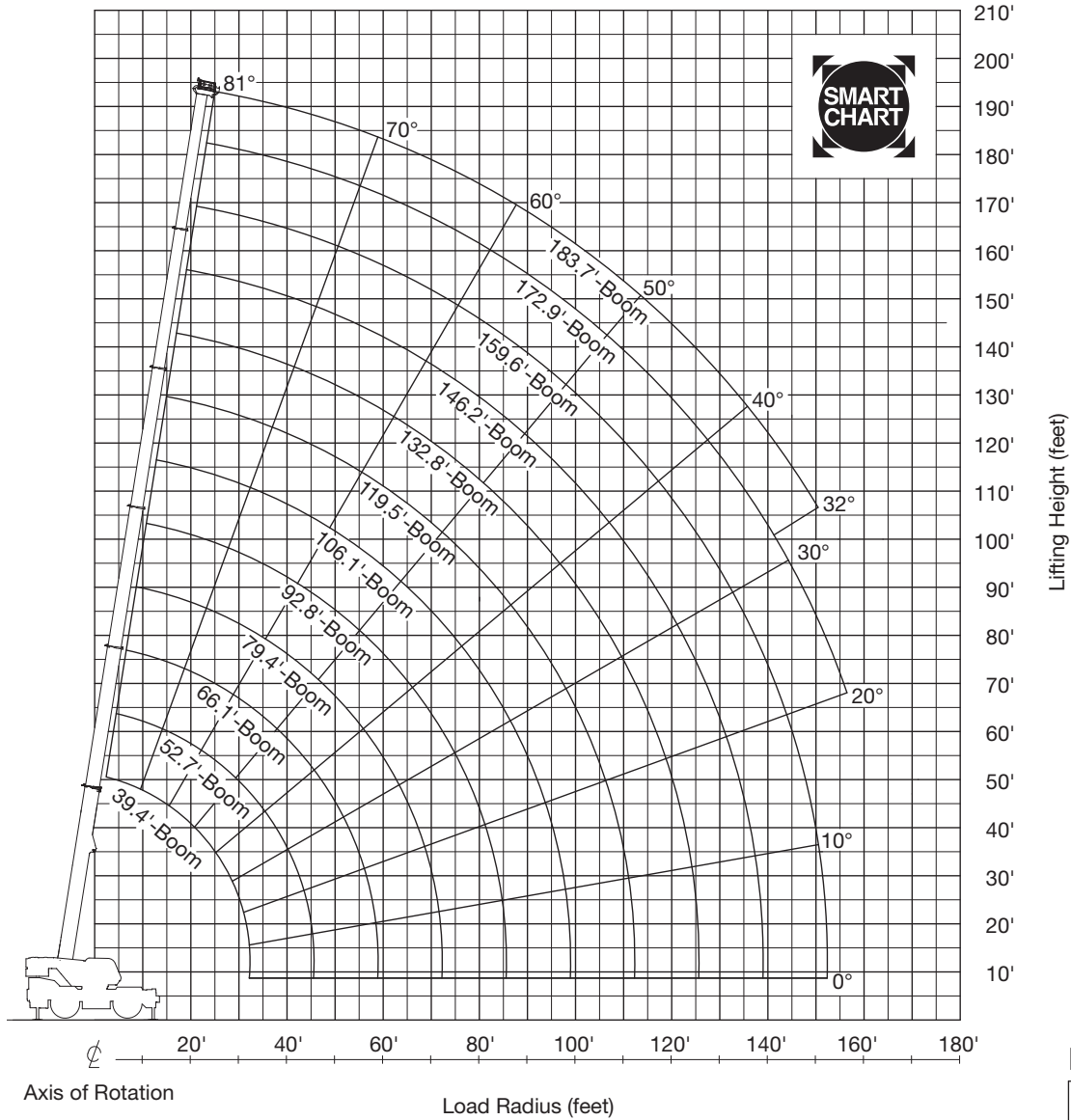

BOOM

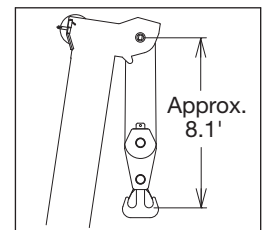

SINGLE TOP

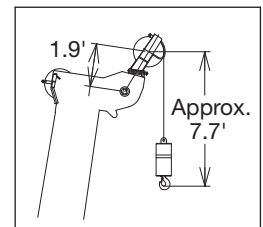

NOTE:
 Boom and jib geometry shown are for unloaded condition and machine standing level on firm supporting surface.
 Boom deflection and subsequent radius and boom angle change must be accounted for when applying load to hook.

Fully extended – 360° – Smart Chart

22,000 lb		23' 11-3/8" spread										360°		
ft	39.4'	52.7'	52.7'	66.1'	66.1'	66.1'	66.1'	79.4'	79.4'	79.4'	79.4'	92.8'	92.8'	92.8'
	1,000 lb													
8	242,500*	143,300	77,200	-	-	-	-	-	-	-	-	-	-	-
10	180,300	143,300	77,200	136,900	110,200	77,200	63,100	-	-	-	-	-	-	-
12	159,000	143,300	77,200	127,400	110,200	77,200	57,800	106,300	106,300	77,200	61,100	-	-	-
15	133,200	132,700	72,100	115,300	110,200	77,200	51,400	97,000	106,300	77,200	55,100	80,700	69,900	48,100
20	101,400	100,500	62,200	97,200	101,400	68,100	43,400	81,800	102,300	71,400	47,400	71,700	69,900	42,500
25	78,000	77,200	54,900	76,700	77,800	60,800	37,500	70,500	78,700	64,600	41,700	62,400	65,700	37,900
30	60,800	59,700	49,400	58,900	60,600	55,300	33,100	60,000	61,900	59,100	37,300	54,700	60,400	34,000
35	-	47,200	45,000	46,300	48,100	50,700	29,500	47,200	49,200	53,100	33,500	48,500	53,400	30,400
40	-	38,100	41,700	37,300	39,000	44,100	26,700	38,100	40,100	44,500	30,600	39,500	44,100	27,600
45	-	31,500	35,700	30,600	32,200	37,300	24,500	31,300	33,300	37,500	28,200	32,600	37,300	25,400
50	-	-	-	25,400	26,900	32,000	22,500	26,200	28,000	32,200	26,000	27,300	31,700	23,400
55	-	-	-	21,400	22,900	27,600	20,900	22,000	23,800	28,000	24,300	23,100	27,600	21,600
60	-	-	-	-	-	-	-	18,500	20,500	24,500	22,900	19,600	24,000	20,100
65	-	-	-	-	-	-	-	15,400	17,400	21,400	21,600	16,500	20,900	18,700
70	-	-	-	-	-	-	-	13,000	14,800	18,700	19,800	13,900	18,300	17,600
75	-	-	-	-	-	-	-	-	-	-	-	11,900	16,100	16,500
80	-	-	-	-	-	-	-	-	-	-	-	9,900	14,100	15,900
85	-	-	-	-	-	-	-	-	-	-	-	8,600	12,600	14,100
	16	10	6	9	8	6	6	7	7	6	5	6	5	4
1)	42,100	41,900	44,100	34,000	39,700	44,100	35,100	35,100	39,200	41,000	35,900	35,300	38,100	35,900
2)	0°	0°	0°	0°	0°	0°	0°	0°	0°	0°	0°	0°	0°	0°
3)	1	10	1	10	11	2	1	11	12	2	1	12	2	1
4)	1	24	2	25	26	12	3	27	28	13	4	29	14	5

Telescopic conditions (%)

1.	0	46	0	92	46	0	0	92	46	0	0	92	0	0
2.	0	0	0	0	46	0	0	46	46	0	0	46	46	0
3.	0	0	0	0	0	0	0	0	46	46	0	46	46	0
4.	0	0	0	0	0	46	0	0	0	46	46	0	46	92
5.	0	0	46	0	0	46	92	0	0	46	92	0	46	92

* Over front with special equipment

- 1) Maximum capacity without boom pin
- 2) Minimum boom angle (°) for indicator length (no load)
- 3) Boom block
- 4) Boom number



Smart Chart

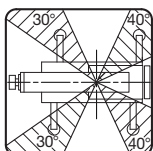

NOTE:

The lifting capacity data stored in the LOAD MOMENT INDICATOR (AML-C) is based on the standard number of parts of line listed in the chart.

Fully extended – 360° – Smart Chart

☰ 22,000 lb		📏 23' 11-3/8" spread														360°	
📏		106.1'	106.1'	106.1'	119.5'	119.5'	119.5'	132.8'	132.8'	132.8'	146.2'	146.2'	146.2'	159.6'	159.6'	172.9'	183.7'
ft	1,000 lb																
20	60,400	56,200	41,200	-	41,000	-	-	-	-	-	-	-	-	-	-	-	-
25	55,100	56,200	37,700	45,600	41,000	33,100	37,300	31,700	31,100	-	-	-	-	-	-	-	-
30	49,800	56,200	34,400	43,900	41,000	30,200	37,300	31,700	29,100	31,700	27,300	26,500	-	-	-	-	-
35	44,500	52,500	31,100	40,100	39,200	27,300	35,700	30,900	27,100	30,900	26,500	26,000	25,600	23,100	20,700	-	-
40	40,100	43,400	28,200	36,600	36,800	25,100	32,800	28,900	25,100	28,900	24,900	24,500	25,600	23,100	20,700	18,100	-
45	34,200	36,400	26,000	33,500	34,400	22,900	30,000	27,100	23,100	26,900	23,400	23,100	24,300	22,500	20,700	18,100	-
50	28,900	31,100	24,000	30,200	32,200	21,200	27,800	25,400	21,600	24,900	21,800	21,600	22,700	21,400	20,500	18,100	-
55	24,500	26,700	22,300	25,800	27,800	19,600	25,800	23,800	20,100	23,100	20,500	20,300	21,400	20,300	19,600	17,900	-
60	20,900	23,400	20,700	22,300	24,300	18,300	22,300	22,500	19,000	21,400	19,400	19,200	19,800	19,400	18,500	17,000	-
65	17,900	20,100	19,400	19,200	21,200	17,000	19,200	21,200	17,600	19,400	18,300	18,100	18,700	18,300	17,400	16,300	-
70	15,200	17,400	18,100	16,500	18,500	15,900	16,500	19,000	16,800	16,800	17,200	17,200	17,200	17,400	16,500	15,400	-
75	13,000	15,200	17,200	14,300	16,300	15,000	14,300	16,800	15,700	14,600	16,300	16,100	15,000	16,300	15,700	14,600	-
80	11,200	13,200	16,100	12,300	14,300	14,100	12,300	14,800	15,000	12,600	14,800	15,000	13,000	14,600	13,700	13,700	-
85	9,700	11,700	14,300	10,800	12,600	13,200	10,800	13,000	13,900	11,000	13,000	13,200	11,500	12,800	12,100	12,100	-
90	8,400	10,400	13,000	9,500	11,200	12,600	9,300	11,700	12,300	9,500	11,700	11,900	10,100	11,500	10,600	10,600	-
95	7,100	9,000	11,700	8,200	9,900	11,500	8,200	10,400	11,200	8,400	10,400	10,600	8,800	10,100	9,500	9,300	-
100	-	-	-	7,100	8,800	10,400	7,100	9,300	10,100	7,300	9,300	9,500	7,700	9,000	8,400	8,200	-
105	-	-	-	6,200	7,900	9,300	6,200	8,400	9,000	6,400	8,400	8,600	6,800	7,900	7,300	7,300	-
110	-	-	-	5,300	7,100	8,600	5,300	7,500	8,200	5,500	7,500	7,700	6,000	7,300	6,400	6,400	-
115	-	-	-	-	-	-	4,400	6,600	7,500	4,600	6,600	6,800	5,100	6,400	5,700	5,700	-
120	-	-	-	-	-	-	3,700	6,000	6,800	4,000	6,000	6,200	4,400	5,700	5,100	4,900	-
125	-	-	-	-	-	-	3,300	5,500	6,200	3,300	5,300	5,500	3,700	5,100	4,400	4,200	-
130	-	-	-	-	-	-	-	-	-	2,900	4,900	5,100	3,300	4,400	3,700	3,700	-
135	-	-	-	-	-	-	-	-	-	2,400	4,400	4,400	2,600	4,000	3,300	3,100	-
140	-	-	-	-	-	-	-	-	-	-	-	-	2,200	3,500	2,600	2,600	-
145	-	-	-	-	-	-	-	-	-	-	-	-	-	3,100	2,200	2,200	-
150	-	-	-	-	-	-	-	-	-	-	-	-	-	2,600	2,000	-	-
📏	4	4	4	4	4	4	4	4	4	4	4	4	4	4	4	4	4
1)	35,300	38,100	36,800	34,000	34,000	33,100	31,700	30,400	30,600	27,300	27,300	26,500	25,600	23,100	20,700	18,100	-
2)	0°	0°	0°	0°	0°	0°	0°	0°	0°	0°	0°	0°	0°	0°	20°	32°	-
3)	13	2	1	2	3	1	5	4	1	6	7	1	8	1	1	9	-
4)	30	15	6	16	17	7	19	18	8	20	21	9	22	10	11	23	-

Telescopic conditions (%)

1.	92	46	0	92	46	0	92	46	0	92	46	0	92	46	92	100
2.	46	46	0	46	46	0	92	46	46	92	46	92	92	92	92	100
3.	46	46	46	46	46	92	46	46	92	92	92	92	92	92	92	100
4.	46	46	92	46	46	92	46	92	92	46	92	92	92	92	92	100
5.	0	46	92	46	92	92	46	92	92	46	92	92	46	92	92	100

- 1) Maximum capacity without boom pin
- 2) Minimum boom angle (°) for indicator length (no load)
- 3) Boom block
- 4) Boom number



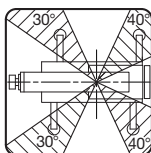

Smart Chart



NOTE:

The lifting capacity data stored in the LOAD MOMENT INDICATOR (AML-C) is based on the standard number of parts of line listed in the chart.

On rubber stationary

22,000 lb		0°*				
 39.4'		52.7'	66.1'	79.4'	92.8'	
ft		1,000 lb				
15	62°	50,400	-	-	-	-
20	53°	38,000	64° 40,300	-	-	-
25	42°	29,400	58° 31,900	65° 33,000	-	-
30	28°	23,300	50° 25,800	60° 26,900	66° 28,000	71° 28,100
35	-	-	42° 21,100	55° 22,300	62° 23,400	67° 23,500
40	-	-	32° 14,900	49° 16,400	58° 19,800	64° 19,900
45	-	-	17° 11,600	42° 13,000	53° 14,200	60° 14,400
50	-	-	-	35° 10,500	48° 11,700	56° 11,800
55	-	-	-	25° 8,500	43° 9,600	52° 9,800
60	-	-	-	-	37° 8,000	48° 8,100
65	-	-	-	-	30° 6,600	43° 6,800
70	-	-	-	-	19° 5,500	38° 5,600
75	-	-	-	-	-	32° 4,700
80	-	-	-	-	-	25° 3,800
85	-	-	-	-	-	13° 3,200
		4	4	4	4	4
2)	0°	0°	0°	0°	0°	0°
Telescopic conditions (%)						
	1.	0	0	0	0	0
	2.	0	0	0	0	0
	3.	0	0	0	0	0
	4.	0	0	0	46	92
	5.	0	46	92	92	92

* over front



1) Loaded boom angle (°)

2) Minimum boom angle (°) for indicator length (no load)

NOTE:

The lifting capacity data stowed in the LOAD MOMENT INDICATOR (AML-C) is based on the standard number of parts of line listed in the chart.

Standard number of parts of line for on-rubber operation should be according to the chart.

22,000 lb		360°				
 39.4'		52.7'	66.1'	79.4'	92.8'	
ft		1,000 lb				
15	63°	30,400	-	-	-	-
20	53°	20,500	64° 23,400	-	-	-
25	42°	10,200	58° 13,200	65° 14,700	-	-
30	28°	6,000	50° 8,800	60° 10,200	66° 11,400	71° 11,700
35	-	-	42° 5,700	55° 7,100	62° 8,300	67° 8,500
40	-	-	32° 3,500	49° 4,900	58° 6,100	64° 6,300
45	-	-	17° 1,900	43° 3,200	53° 4,400	60° 4,600
50	-	-	-	35° 1,900	48° 3,000	56° 3,200
55	-	-	-	-	43° 2,000	52° 2,200
60	-	-	-	-	-	-
65	-	-	-	-	-	-
70	-	-	-	-	-	-
75	-	-	-	-	-	-
80	-	-	-	-	-	-
85	-	-	-	-	-	-
		4	4	4	4	4
2)	0°	0°	27°	37°	48°	
Telescopic conditions (%)						
	1.	0	0	0	0	0
	2.	0	0	0	0	0
	3.	0	0	0	0	0
	4.	0	0	0	46	92
	5.	0	46	92	92	92

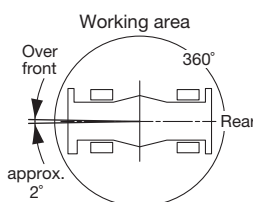

Operation

On rubber creep

22,000 lb		0°*				
ft	1)	39.4'	52.7'	66.1'	79.4'	92.8'
1,000 lb						
15	62°	37,600	-	-	-	-
20	53°	27,400	64° 29,500	-	-	-
25	42°	20,600	57° 22,700	65° 24,000	-	-
30	27°	15,700	50° 17,900	60° 19,200	66° 20,300	70° 20,300
35	-	-	42° 14,200	54° 15,500	62° 16,600	67° 16,700
40	-	-	32° 11,300	49° 12,600	57° 13,700	63° 13,900
45	-	-	16° 9,000	42° 10,300	53° 11,400	60° 11,600
50	-	-	-	34° 8,400	48° 9,500	56° 9,700
55	-	-	-	25° 6,900	42° 8,000	52° 8,100
60	-	-	-	-	36° 6,700	48° 6,800
65	-	-	-	-	29° 5,500	43° 5,700
70	-	-	-	-	19° 4,600	38° 4,700
75	-	-	-	-	-	32° 3,900
80	-	-	-	-	-	25° 3,100
85	-	-	-	-	-	13° 2,500
2)		0°	0°	0°	0°	0°

Telescopic conditions (%)

1.	0	0	0	0	0
2.	0	0	0	0	0
3.	0	0	0	0	0
4.	0	0	0	46	92
5.	0	46	92	92	92

* over front

1) Loaded boom angle (°)

2) Minimum boom angle (°) for indicator length (no load)

NOTE:

The lifting capacity data stowed in the LOAD MOMENT INDICATOR (AML-C) is based on the standard number of parts of line listed in the chart.

Standard number of parts of line for on-rubber operation should be according to the chart.

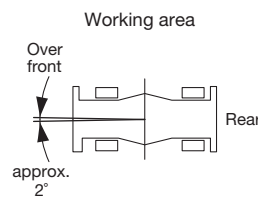

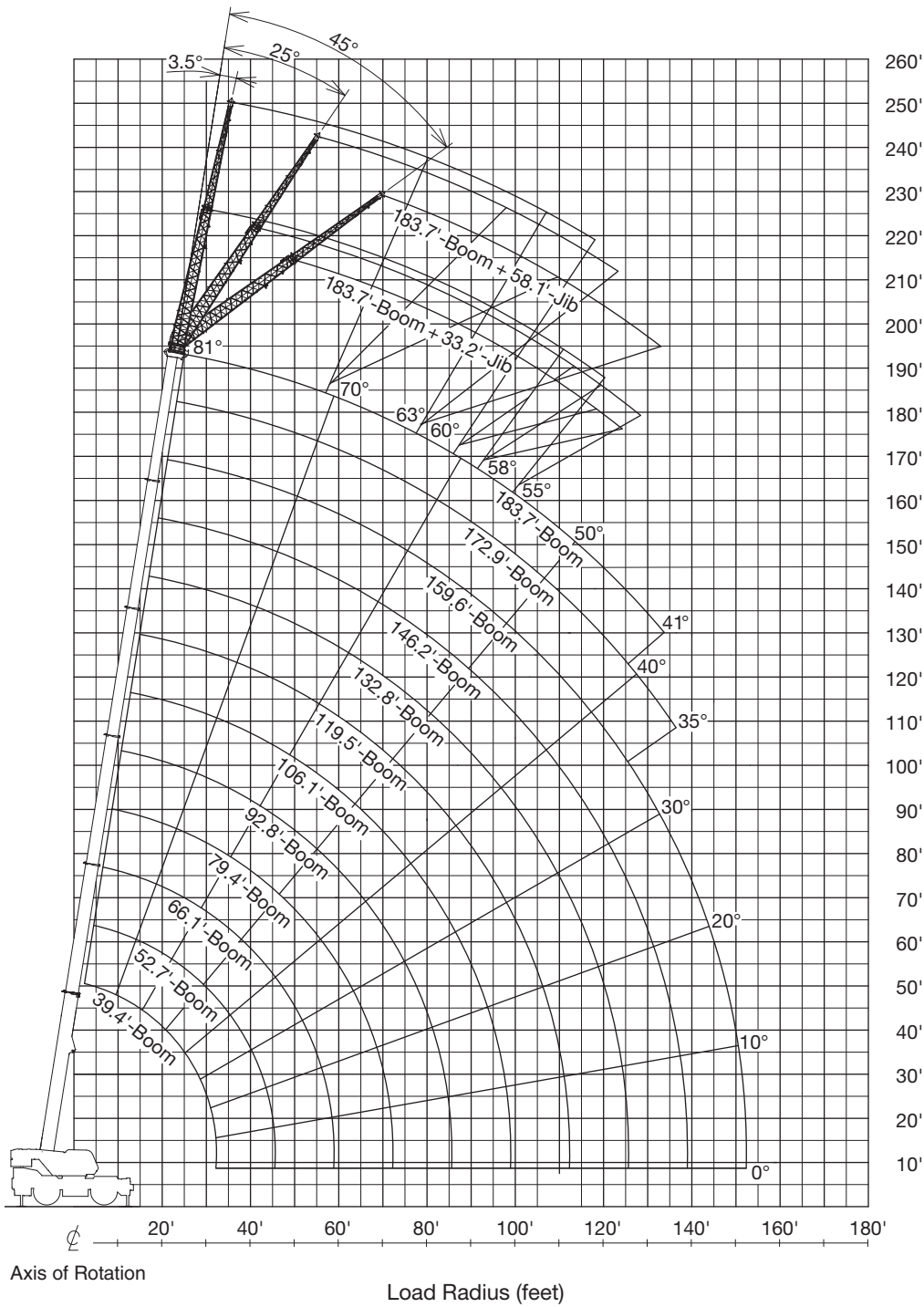

Lifting Height (feet)

BOOM

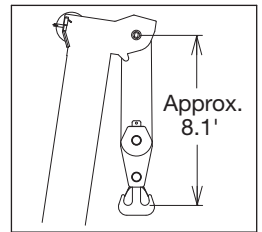

JIB

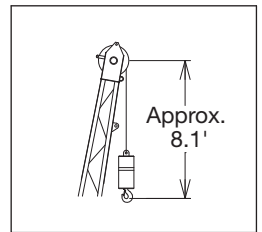

SINGLE TOP

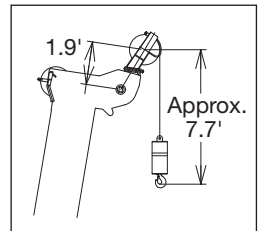

NOTE:
 Boom and jib geometry shown are for unloaded condition and machine standing level on firm supporting surface.
 Boom deflection and subsequent radius and boom angle change must be accounted for when applying load to hook.

Operation

Fully extended – 360°

22,000 lb							23' 11-3/8" spread							33.2'							360°						
							183.7'														172.9'						
							3.5° 3.5° 25° 25° 45° 45°														3.5° 3.5° 25° 25° 45° 45°						
							1)														1)						
							2)														2)						
							1,000 lb														1,000 lb						
81°	45.7'	9,900	57.0'	8,600	67.2'	7,900	81°	43.7'	11,000	55.0'	9,500	63.5'	8,400														
80°	50.2'	9,900	60.8'	8,400	70.8'	7,700	80°	47.4'	11,000	58.2'	9,300	66.8'	8,400														
79°	54.6'	9,700	64.8'	8,200	74.5'	7,500	79°	51.2'	10,800	61.8'	9,000	70.1'	8,200														
78°	59.0'	9,500	68.5'	7,900	78.0'	7,300	78°	55.3'	10,600	65.4'	8,800	73.4'	7,900														
77°	62.6'	9,000	72.5'	7,700	82.0'	7,100	77°	57.7'	10,100	68.9'	8,600	77.0'	7,700														
76°	66.8'	8,800	76.6'	7,700	85.0'	7,100	76°	62.6'	9,900	72.4'	8,400	80.0'	7,500														
75°	71.2'	8,600	80.4'	7,500	89.0'	6,800	75°	66.2'	9,700	75.9'	8,200	83.0'	7,500														
73°	79.0'	8,200	88.0'	7,100	96.0'	6,600	73°	73.3'	9,000	83.0'	7,700	90.0'	7,300														
70°	91.0'	7,500	99.0'	6,600	106.0'	6,400	70°	84.1'	8,400	93.0'	7,300	100.0'	6,800														
68°	99.0'	7,100	106.0'	6,400	113.0'	6,200	68°	91.0'	7,900	100.0'	7,100	106.0'	6,600														
65°	108.0'	5,500	115.0'	5,100	122.0'	5,100	65°	101.0'	7,100	110.0'	6,400	115.0'	6,200														
63°	113.0'	4,400	121.0'	4,200	127.0'	4,200	63°	107.0'	6,000	116.0'	5,300	120.0'	5,300														
60°	122.0'	3,300	129.0'	3,300	135.0'	3,300	60°	116.0'	4,600	123.0'	4,200	127.0'	4,200														
58°	127.0'	2,600	134.0'	2,600	140.0'	2,600	58°	121.0'	3,700	130.0'	3,500	132.0'	3,500														
55°	135.0'	1,800	142.0'	1,800	-	-	55°	129.0'	2,900	135.0'	2,600	139.0'	2,600														
53°	-	-	-	-	-	-	53°	134.0'	2,200	140.0'	2,200	143.0'	2,200														
50°	-	-	-	-	-	-	50°	141.0'	1,500	147.0'	1,500	-	-														

159.6'							106.1'						
3.5° 3.5° 25° 25° 45° 45°							3.5° 3.5° 25° 25° 45° 45°						
1)							1)						
2)							2)						
1,000 lb							1,000 lb						
81°	39.9'	13,200	51.3'	11,500	59.7'	9,900	81°	22.7'	14,600	36.6'	14,600	43.0'	10,800
80°	43.3'	13,200	54.3'	11,000	62.6'	9,700	80°	25.4'	14,600	39.0'	14,100	45.5'	10,600
79°	47.4'	13,200	57.6'	10,800	65.9'	9,700	79°	27.9'	14,600	41.6'	13,900	47.9'	10,600
78°	51.0'	13,000	60.9'	10,600	69.0'	9,500	78°	30.6'	14,600	44.2'	13,400	50.1'	10,400
77°	54.3'	12,600	64.2'	10,400	72.0'	9,300	77°	33.3'	14,600	46.7'	13,200	52.2'	10,100
76°	57.6'	12,100	67.5'	10,100	75.0'	9,000	76°	35.8'	14,600	49.2'	12,800	54.4'	10,100
75°	61.0'	11,900	70.7'	9,900	79.0'	9,000	75°	38.4'	14,600	51.5'	12,600	56.5'	9,900
73°	67.5'	11,000	77.5'	9,500	84.0'	8,600	73°	43.5'	14,600	56.0'	12,100	60.6'	9,900
70°	77.6'	10,100	87.0'	9,000	94.0'	8,400	70°	51.0'	14,600	62.9'	11,700	66.7'	9,700
68°	84.2'	9,700	93.0'	8,600	100.0'	8,200	68°	55.8'	14,600	67.2'	11,200	70.6'	9,500
65°	93.0'	8,200	102.0'	7,300	107.0'	7,100	65°	62.5'	14,600	73.5'	10,800	76.2'	9,300
63°	99.0'	7,100	107.0'	6,400	112.0'	6,200	63°	67.0'	14,600	77.5'	10,600	80.2'	9,300
60°	107.0'	5,500	115.0'	5,100	118.0'	4,900	60°	73.3'	13,700	83.0'	10,400	85.4'	9,300
58°	113.0'	4,600	119.0'	4,400	123.0'	4,200	58°	77.5'	13,200	87.0'	10,400	88.8'	9,300
55°	120.0'	3,500	126.0'	3,300	129.0'	3,300	55°	83.4'	12,600	93.0'	10,100	93.8'	9,000
53°	124.0'	3,100	131.0'	2,900	134.0'	2,900	53°	86.9'	11,500	96.0'	9,900	96.9'	9,000
50°	131.0'	2,200	137.0'	2,200	140.0'	2,200	50°	92.2'	9,900	101.0'	9,000	101.0'	8,800
48°	136.0'	1,800	141.0'	1,800	144.0'	1,800	48°	95.6'	9,000	104.0'	8,400	104.0'	8,200
45°	142.0'	1,300	-	-	-	-	45°	100.0'	8,200	108.0'	7,500	108.0'	7,300
43°	-	-	-	-	-	-	43°	104.0'	7,500	110.0'	7,100	-	-
40°	-	-	-	-	-	-	40°	108.0'	6,600	114.0'	6,400	-	-
38°	-	-	-	-	-	-	38°	111.0'	6,200	116.0'	6,000	-	-
35°	-	-	-	-	-	-	35°	115.0'	5,700	120.0'	5,500	-	-
33°	-	-	-	-	-	-	33°	117.0'	5,300	122.0'	5,100	-	-
30°	-	-	-	-	-	-	30°	121.0'	4,900	124.0'	4,600	-	-
25°	-	-	-	-	-	-	25°	125.0'	4,200	128.0'	4,200	-	-
20°	-	-	-	-	-	-	20°	129.0'	3,700	-	-	-	-
15°	-	-	-	-	-	-	15°	132.0'	3,500	-	-	-	-
10°	-	-	-	-	-	-	10°	134.0'	3,300	-	-	-	-

1) Loaded boom angle (°)

2) Rated lifting capacity in pounds

Operation

Fully extended – 360°

22,000 lb							23' 11-3/8" spread							58.1'							360°													
							183.7'														172.9'													
							3.5° 3.5° 25° 25° 45° 45°														3.5° 3.5° 25° 25° 45° 45°													
							1)							2)							1)							2)						
							1,000 lb														1,000 lb													
81°	53.1'	6,400	75.3'	6,000	89.8'	5,100	81°	50.0'	6,800	69.8'	6,200	86.1'	5,100																					
80°	58.1'	6,400	79.8'	5,700	93.7'	4,900	80°	54.0'	6,800	75.0'	6,200	89.7'	5,100																					
79°	63.4'	6,400	84.0'	5,500	98.0'	4,900	79°	59.0'	6,800	78.9'	6,000	93.3'	5,100																					
78°	68.2'	6,400	88.8'	5,500	102.0'	4,900	78°	63.5'	6,800	82.6'	5,700	96.9'	4,900																					
77°	73.6'	6,400	93.0'	5,300	106.0'	4,600	77°	68.1'	6,800	86.8'	5,700	101.0'	4,900																					
76°	78.8'	6,400	97.3'	5,300	110.0'	4,600	76°	72.6'	6,800	90.9'	5,500	104.0'	4,900																					
75°	83.3'	6,200	101.4'	5,100	114.0'	4,600	75°	77.2'	6,800	94.9'	5,500	107.0'	4,600																					
73°	93.0'	6,000	110.0'	4,900	121.0'	4,400	73°	85.9'	6,600	103.0'	5,300	114.0'	4,600																					
70°	106.4'	5,500	122.0'	4,600	131.0'	4,200	70°	98.9'	6,200	114.0'	5,100	124.0'	4,400																					
68°	114.0'	4,900	129.0'	4,200	138.0'	4,000	68°	107.0'	5,700	122.0'	4,900	131.0'	4,400																					
65°	123.0'	3,500	138.0'	3,100	146.0'	2,900	65°	118.0'	4,900	132.0'	4,200	140.0'	3,700																					
63°	129.0'	2,600	144.0'	2,400	152.0'	2,400	63°	124.0'	4,000	137.0'	3,300	145.0'	3,300																					
60°	138.0'	1,800	-	-	-	-	60°	132.0'	2,900	145.0'	2,400	152.0'	2,400																					
58°	-	-	-	-	-	-	58°	138.0'	2,200	150.0'	2,000	157.0'	2,000																					
55°	-	-	-	-	-	-	55°	146.0'	1,500	-	-	-	-																					

159.6'						
3.5° 3.5° 25° 25° 45° 45°						
1)						
2)						
1,000 lb						
81°	46.3'	7,700	66.3'	6,600	80.7'	5,300
80°	50.1'	7,700	70.2'	6,600	83.8'	5,100
79°	54.7'	7,700	73.9'	6,400	87.6'	5,100
78°	58.9'	7,700	77.5'	6,200	90.9'	5,100
77°	63.1'	7,700	81.3'	6,200	94.0'	4,900
76°	67.2'	7,700	84.8'	6,000	97.3'	4,900
75°	71.8'	7,700	88.9'	6,000	101.0'	4,900
73°	80.0'	7,700	96.1'	5,700	107.0'	4,900
70°	91.7'	7,300	106.0'	5,300	117.0'	4,600
68°	99.8'	7,100	114.0'	5,100	123.0'	4,600
65°	110.0'	6,000	124.0'	5,100	132.0'	4,400
63°	116.0'	5,100	130.0'	4,400	137.0'	4,000
60°	124.0'	3,700	137.0'	3,300	143.0'	3,100
58°	129.0'	3,100	142.0'	2,900	148.0'	2,600
55°	137.0'	2,200	149.0'	2,000	154.0'	2,000
53°	142.0'	1,800	154.0'	1,500	-	-
50°	-	-	-	-	-	-
48°	-	-	-	-	-	-
45°	-	-	-	-	-	-
43°	-	-	-	-	-	-
40°	-	-	-	-	-	-
38°	-	-	-	-	-	-
35°	-	-	-	-	-	-
33°	-	-	-	-	-	-
30°	-	-	-	-	-	-
25°	-	-	-	-	-	-
20°	-	-	-	-	-	-
15°	-	-	-	-	-	-
10°	-	-	-	-	-	-

106.1'						
3.5° 3.5° 25° 25° 45° 45°						
1)						
2)						
1,000 lb						
81°	30.1'	9,900	51.8'	7,300	64.7'	5,300
80°	33.3'	9,900	54.7'	7,100	67.2'	5,100
79°	36.5'	9,900	57.4'	6,800	69.6'	5,100
78°	39.7'	9,900	60.0'	6,600	72.0'	5,100
77°	42.8'	9,900	62.8'	6,600	74.4'	4,900
76°	46.0'	9,900	65.5'	6,400	76.6'	4,900
75°	48.8'	9,900	68.2'	6,400	79.0'	4,900
73°	54.7'	9,900	73.6'	6,200	83.6'	4,900
70°	63.0'	9,000	80.8'	5,700	89.9'	4,600
68°	68.1'	8,400	85.9'	5,500	94.3'	4,600
65°	76.1'	7,900	92.8'	5,300	100.0'	4,400
63°	80.9'	7,500	97.6'	5,300	104.0'	4,400
60°	88.5'	7,100	104.0'	5,100	110.0'	4,400
58°	93.4'	7,100	108.0'	5,100	113.0'	4,400
55°	100.0'	6,600	114.0'	4,900	118.0'	4,400
53°	105.0'	6,400	118.0'	4,900	121.0'	4,200
50°	111.0'	6,200	124.0'	4,600	126.0'	4,200
48°	115.0'	6,000	127.0'	4,600	128.0'	4,200
45°	121.0'	5,700	132.0'	4,600	132.0'	4,200
43°	125.0'	5,300	135.0'	4,600	-	-
40°	130.0'	4,900	139.0'	4,400	-	-
38°	133.0'	4,400	141.0'	4,000	-	-
35°	137.0'	4,000	144.0'	3,700	-	-
33°	140.0'	3,700	146.0'	3,500	-	-
30°	144.0'	3,300	149.0'	3,100	-	-
25°	149.0'	2,900	152.0'	2,600	-	-
20°	154.0'	2,600	-	-	-	-
15°	157.0'	2,200	-	-	-	-
10°	159.0'	2,200	-	-	-	-

- 1) Loaded boom angle (°)
- 2) Rated lifting capacity in pounds

Notes to Lifting Capacity

GENERAL

1. RATED LIFTING CAPACITIES apply only to the machine as originally manufactured and normally equipped by TADANO LTD. Modifications to the machine or use of optional equipment other than that specified can result in a reduction of capacity.
2. Hydraulic cranes can be hazardous if improperly operated or maintained. Operation and maintenance of this machine must be in compliance with information, in the operation and maintenance manual supplied with the crane. If this manual is missing, order a replacement through the distributor.
3. The operator and other personnel associated with this machine shall fully acquaint themselves with the latest American National Standards Institute (ANSI) safety standards for cranes.

SET UP

1. Rated lifting capacities on the chart are the maximum allowable crane capacities and are based on the machine standing level on firm supporting surface under ideal job conditions. Depending on the nature of the supporting surface, it may be necessary to have structural supports under the outrigger floats or tires to spread the loads to a larger bearing surface.
2. For outrigger operation, outriggers shall be properly extended with tires free of supporting surface before operating crane.

OPERATION

1. Rated lifting capacities have been tested to and meet minimum requirements of SAE J1063-Cantilevered Boom Crane Structures Method of Test.
2. Rated lifting capacities do not exceed 85% of the tipping load on outriggers fully extended as determined by SAE J765-Crane Stability Test Code.
Rated lifting capacities for partially extended outriggers are determined from the formula, rated lifting capacities = (tipping load - 0.1 × tip reaction) / 1.25.
3. Rated lifting capacities above thick lines in the chart are based on crane strength and those below, on its stability. They are based on actual load radius increased by boom deflection.
4. The weight of handling device such as hook blocks, slings, etc., must be considered as part of the load and must be deducted from the lifting capacities.
5. Rated lifting capacities are based on freely suspended loads and make no allowance for such factors as the effect of wind, sudden stopping of loads, supporting surface conditions, inflation of tires, operating speeds, side loads, etc. Side pull on the boom or jib is extremely dangerous. Such action can damage the boom, jib or swing mechanism, and lead to overturning of the crane.
6. Rated lifting capacities do not account for wind on lifted load or boom. We recommend against working under the condition that the load is out of control due to a strong wind. During boom lift, consider that the rated lifting capacity is reduced by 50% when the wind speed is 20 mph to 27 mph; reduced by 70% when the wind speed is 27 mph to 31 mph. If the wind speed is 31 mph or over, stop operation. However, in the following conditions, stop operation at wind speed of 27 mph: Boom length is 183.7' (all 100%), and boom angle is 55° or less. Boom length is 172.9' (all 92%), and boom angle is 45° or less. During jib lift, stop operation if the wind speed is 20 mph or over.
7. Rated lifting capacities at load radius shall not be exceeded. Do not tip the crane to determine allowable loads.
8. Do not operate at boom lengths, radii, or boom angle, where no capacities are shown. Crane may overturn without any load on the hook.
9. When boom length is between values listed, refer to the rated lifting capacities of the next longer and next shorter booms for the same radius. The lesser of the two rated lifting capacities shall be used.
10. When making lifts at a load radius not shown, use the next longer radius to determine allowable capacity.
11. Load per line should not exceed 15,900 lb for main winch and auxiliary winch.
12. Check the actual number of parts of line with LOAD MOMENT INDICATOR (AML-C) before operation. Maximum lifting capacity is restricted by the number of parts of line of LOAD MOMENT INDICATOR (AML-C). Limited capacity is as determined from the formula, single line pull for main winch 15,900 lb x number of parts of line.
13. The boom angle before loading should be greater to account for deflection. For rated lifting capacities, the loaded boom angle and the load radius is for reference only.
14. Maximum capacity without boom pin is shown in the chart.
15. Do not operate extension or retraction of the boom with loads.
16. For lifting capacity of single top, deduct the weight of the load handling equipment from the rated lifting capacity of the boom.
For the lifting capacity of single top, the net capacity shall not exceed 15,900 lb including main boom hook mass attached to the boom.
17. When the base jib or top jib or both jibs are removed, set the jib status switch to the DISMOUNTED position.
18. When erecting and stowing jib, be sure to retain it by hand or by other means to prevent its free movement.
19. Use "ANTI-TWO BLOCK" disable switch when erecting and stowing jib and when stowing hook block.
While the switch is pushed, the hoist does not stop, even when overwind condition occurs.
20. For selected boom length or less with jib, rated lifting capacities are determined by loaded boom angle only in the column headed "selected boom + jib".

Notes to Lifting Capacity

21. The boom extending operation and lowering operation are prohibited during lifting a load with multiple line lift. When lifting a load by using jib (aux. winch) and boom (main winch) simultaneously, do the following:
 - Enter the operation status as jib operation, not as boom operation.
 - Before starting operation, make sure that the mass of a load is within the rated lifting capacity for the jib. (The AML display indicates inaccurate working radius and actual load values during multiple line lift.)
 When lifting a load by using single top (aux. winch) and boom (main winch) simultaneously, do the following:
 - Enter the operation status as single top operation, not as boom operation.
 - Before starting operation, make sure that the mass of a load is within the rated lifting capacity for the single top. (The AML display indicates inaccurate working radius and actual load values during multiple line lift.)
22. Crane operation is prohibited without full counterweight 22,000 lb installed. Outriggers shall be extended 23'11-3/8" spread when installing or removing removable counterweight.

DEFINITIONS

1. Load radius: Horizontal distance from a projection of the axis of rotation to supporting surface before loading to the center of the vertical hoist line or tackle with load applied.
2. Loaded boom angle: The angle between the boom base section and the horizontal, after lifting the rated lifting capacity at the load radius.
3. Working area: Area measured in a circular arc about the centerline of rotation.
4. Freely suspended load: Load hanging free with no direct external force applied except by the hoist line.
5. Side load: Horizontal side force applied to the lifted load either on the ground or in the air.

Warning and Operating Instructions Notes for on Rubber Lifting Capacities

1. Rated lifting capacities on-rubber are in pounds and do not exceed 75% of tipping loads as determined by SAE J765-Crane Stability Test Code.
2. Rated lifting capacities shown in the chart are based on condition that crane is set on firm level surfaces with suspension-lock applied. Those above thick lines are based on tire capacity and those below, on crane stability. They are based on actual load radius increased by tire deformation and boom deflection.
3. If the suspension-lock cylinders contain air, the axle will not be locked completely and rated lifting capacities may not be obtainable. Bleed the cylinders according to the operation safety and maintenance manual.
4. Rated lifting capacities are based on proper tire inflation, capacity and condition. Damaged tires are hazardous to safe operation of crane.
5. Tires shall be inflated to correct air pressure. Tires: 29.5-25 34PR – air pressure: 57 psi.
6. Over front operation shall be performed within 2 degrees in front of chassis.
7. On-rubber lifting with "jib" is not permitted. Maximum permissible boom length is 92.8'.
8. When making lift on-rubber stationary, set parking brake.
9. For creep operation, boom must be centered over front of machine, slewing lock engaged, and load restrained from slewing. Travel slowly and keep the lifted load as close to the ground as possible, and especially avoid any abrupt steering, accelerating or braking.
10. Do not operate the crane while carrying the load.
11. Creep is motion for crane not to travel more than 200 ft in any 30 minute period and to travel at the speed of less than 1 mph.
12. For creep operation, choose the drive mode and proper gear according to the road or working condition.
13. The mass of the hook (2,380 lb for 120 ton capacity, 660 lb for 7.9 ton capacity), slings and all similarly used load handling devices must be considered as part of the load and must be deducted from the lifting capacities.
14. For rated lifting capacity of single top, reduce the rated lifting capacities of relevant boom according to a weight reductions for auxiliary load handling equipment. Capacities of single top shall not exceed 15,900 lb including main hook.
15. The lifting capacity data stowed in the LOAD MOMENT INDICATOR (AML-C) is based on the standard number of parts of line listed in the chart. Standard number of parts of line for on rubber operation should be according to the following table.

Boom length in feet	39.4' to 92.8'	Single top jib
Number of parts of line	4	1

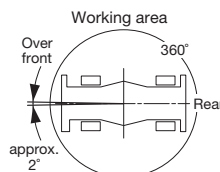

Notes for Load Moment Indicator (AML-C)

1. Set AML select keys in accordance with the actually operating crane conditions and don't fail to make sure, before crane operation, that the displays on front panel are correct.
2. When operating crane on outriggers:
 - Set "P.T.O." switch to "ON".
 - Press the outrigger state select key to register for the outrigger operation. If the display agrees with the actual state, press the set key to register. After the completion of the registration, the pop-up window closes.
 - Press the lift state select key to register the lift state to be used (single top/jib/boom).
 - Each time the lift state select key is pressed, the display changes. If the display agrees with the actual state, press the set key to register. After the completion of the registration, the pop-up window closes.
 - When erecting and stowing jib, select the status of jib set (jib lift indicator symbol flickers).
3. When operating crane on-rubber:
 - Set "P.T.O." switch to "ON".
 - Press the outrigger state select key to register for the on-rubber operation. Each time the outrigger state select key is pressed, the display changes. Select the creep operation, the on-rubber state indicator symbol flickers.
 - Press the lift state select key to register the lift state.However, pay attention to the following.
 - (1) For stationary operation.
 - The front capacities are attainable only when the over front position symbol comes on. When the boom is more than 2 degrees from centered over front of chassis, 360° capacities are in effect.
 - When a load is lifted in the front position and then slewed to the side area, make sure the value of the LOAD MOMENT INDICATOR (AML-C) is below the 360° lifting capacity.
 - (2) For creep operation.
 - The creep capacities are attainable only when boom is in the straight forward position of chassis and the over front position symbol is on. If boom is not in the straight forward position of chassis, never lift load.
4. This machine is equipped with an automatic swing stopping device (for the details, see operation and maintenance manual). But, operate very carefully because the automatic swing stop does not work in the following cases.
 - During on-rubber operation.
 - When the "P.T.O." switch is set to "OVERRIDE" and the "OVERRIDE" key switch outside the cab is on.
5. During crane operation, make sure that the displays on front panel are in accordance with actual operating conditions.
6. THE displayed values of LOAD MOMENT INDICATOR (AML-C) are based on freely suspended loads and make no allowance FOR such factors as the effect of wind, sudden stopping of loads, supporting surface conditions, inflation of tire, operating speed, side loads, etc. For safe operation, it is recommended when extending and lowering boom or swinging, lifting loads shall be appropriately reduced.
7. LOAD MOMENT INDICATOR (AML-C) is intended as an aid to the operator. Under no condition should it be relied upon to replace use of capacity charts and operating instruction. Sole reliance upon LOAD MOMENT INDICATOR (AML-C) aids in place of good operating practice can cause an accident. The operator must exercise caution to assure safety.
8. The lifting capacity differs depending on the outrigger extension width and slewing position. Work with the capacity corresponding to the outrigger extension width and slewing position. For the relationship among the outrigger extension width, slewing position and lifting capacities, refer to the working area charts.

TECHNICAL DESCRIPTION

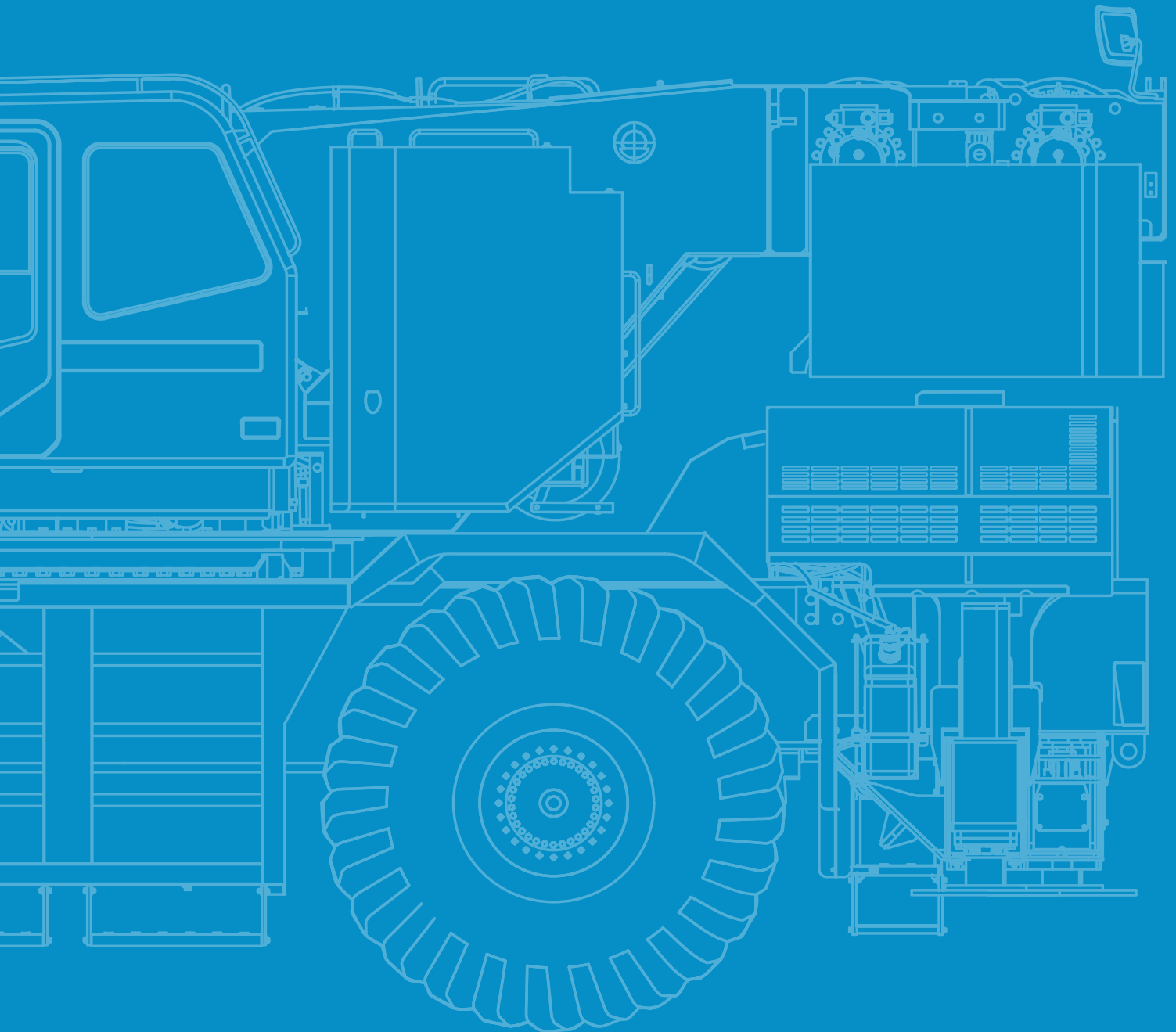

Technical Description

Crane specifications

Boom	6 sections boom of round box construction with 5 sheaves at boom head, extended by single telescoping cylinder. 2 easily removable wire rope guards, rope dead end provided on both sides of boom head. Boom telescope sections are supported by wear pads both vertically and horizontally. Fully retracted length: 39.4' · Fully extended length: 183.7' · Extension speed: 144.3' in 340 s · Sheave root diameter: 15-3/4".
Boom elevation	By a double acting hydraulic cylinder with holding valve. Boom angle indicator. Automatic speed reduction and slow stop function. Boom angle: -1.5-81° · Boom raising speed: 20° to 60° in 40 s.
Jib	2 stage bi-fold lattice type, 3.5°, 25° or 45° offset. Single sheave at the head of both jib sections. Stowed alongside base boom section. Assistant cylinders for mounting and stowing, controlled at right side of superstructure. Self stowing jib mounting pins. Length: 33.2'; 58.1' · Offset: 3.5°, 25°, 45° · Sheave root diameter: 15-5/8".
Auxiliary lifting sheave (single top)	Single sheave, mounted to main boom head for single line work (stowable). Root diameter: 17-5/16".
Anti-two block device	Pendant type over-winding cut out device with audio-visual (FAILURE lamp/BUZZER) warning system.
Slewing	Hydraulic axial piston motor driven through planetary slewing speed reducer. Continuous 360° full circle slewing on ball bearing turn table at 1.5 min ⁻¹ {rpm}. Equipped with manually locked/released slewing brake. A 360° positive swing lock manually engaged in cab. Twin slewing system: Free slewing or lock slewing controlled by selector switch on front console. Slewing speed: 1.5 min ⁻¹ {rpm}.
Counterweight	Standard weight: 22,000 lb.
Winch	<p>MAIN WINCH: Variable speed type with grooved drum driven by hydraulic axial piston motor through speed reducer. Power load lowering and raising. Equipped with automatic brake (neutral brake) and counterbalance valve. Controlled independently of auxiliary winch. Equipped with cable follower and drum rotation indicator.</p> <p>MAIN DRUM: Root diameter x wide: 15" x 29-1/4". Wire rope diameter x length: 3/4" x 984'. Drum capacity: 1293', 7 layers. Maximum single line pull (1st layer): 21,800 lb. Maximum permissible linepull wire strength: 15,900 lb.</p> <p>AUXILIARY WINCH: Variable speed type with grooved drum driven by hydraulic axial piston motor through speed reducer. Power load lowering and raising. Equipped with automatic brake (neutral brake) and counterbalance valve. Controlled independently of main winch. Equipped with cable follower and drum rotation indicator.</p> <p>AUXILIARY DRUM: Root diameter x wide: 15" x 29-1/4". Wire rope diameter x length: 3/4" x 518'. Drum capacity: 1293', 7 layers. Maximum single line pull (1st layer): 21,800 lb. Maximum permissible linepull wire strength: 15,900 lb.</p> <p>WIRE ROPE: Non-rotating 3/4" 7 x 35 class. Breaking strength 79,400 lb.</p>
Hook blocks	120 ton - 8 sheaves with hook block and safety latch. 77 ton - 5 sheaves with hook block and safety latch. 50 ton - 3 sheaves with hook block and safety latch. 7.9 ton - Weighted hook with swivel and safety latch.
Hydraulic system	<p>PUMPS: 2 variable piston pumps for crane functions. Tandem gear pump for steering, swing and optional equipment. Powered by carrier engine. Pump disconnect for crane is engaged/disengaged by rotary switch from operator's cab.</p> <p>CONTROL VALVES: Multiple valves actuated by pilot pressure with integral pressure relief valves.</p> <p>RESERVOIR: 202 gallons capacity. External sight level gauge.</p> <p>FILTRATION: BETA10 = 10 return filter, full flow with bypass protection, located inside of hydraulic reservoir. Accessible for easy replacement.</p> <p>OIL COOLER: Air cooled fan type.</p>
Cab and controls	Both crane and drive operations can be performed from one cab mounted on rotating superstructure. 15° tilt, left side, 1 man type, steel construction with sliding door access and safety glass windows opening at side. Door window is powered control. Windshield glass window and roof glass window are shatter-resistant. Tilt-telescoping steering wheel. Adjustable control lever stands for swing, boom elevating, boom telescoping, auxiliary winch and main winch. Control lever stands can change neutral positions and tilt for easy access to cab. 3 way adjustable operator's seat with high back, headrest and armrest. Engine throttle knob. Foot operated controls: boom elevating boom telescoping, service brake and engine throttle. Hot water cab heater and air conditioning. Dash-mounted engine start/stop, monitor lamps, cigarette lighter, drive selector switch, parking brake switch, steering mode select switch, power window switch, pump engaged/disengaged switch, swing brake switch, telescoping/auxiliary winch select switch, outrigger controls, free swing/lock swing selector switch, eco mode switch, high speed winch (main/aux.) switch and ashtray. Instruments: Torque converter oil temperature, engine water temperature, air pressure, fuel, speedometer, tachometer, hour meter and odometer/tripmeter. Hydraulic oil pressure is monitored and displayed on the AML-C display panel.

Technical Description

Crane specifications

Tadano electronic LOAD MOMENT INDICATOR system (AML-C) including:
 Control lever lockout function with audible and visual pre-warning. Boom position indicator. Outrigger state indicator. Boom angle / boom length / jib offset angle / jib length / load radius / rated lifting capacities / actual loads read out. Ratio of actual load moment to rated load moment indication. Automatic speed reduction and slow stop function on boom elevation and slewing. Working condition register switch. Load radius / boom angle / tip height / slewing range preset function. External warning lamp. Tare function. Fuel consumption monitor. Main winch / auxiliary winch select. Drum rotation indicator (audible and visible type) main and auxiliary winch.

TADANO AML-C monitors outrigger extended length and automatically programs the corresponding "RATED LIFTING CAPACITIES" table.

Operator's right hand console includes transmission gear selector and sight level bubble. Upper console includes working light switch, roof washer and wiper switch emergency outrigger set up key switch, jib equipped/removed select switch, eco mode switch, high speed winch (main/aux.) switch, cab tilt switch. Slewing lock lever.

NOTE: Each crane motion speed is based on unladen conditions.

Carrier specifications

Type	Rear engine, left hand steering, driving axle 2-way selected type by manual switch, 4 x 2 front drive, 4 x 4 front and rear drive.
Frame	High tensile steel, all welded mono-box construction.
Engine	Model: Cummins QSB6.7 EPA Tier4 Final · Type: Direct injection diesel · No. of cylinders: 6 · Combustion: 4 cycle, turbo charged and after cooled · Bore x stroke: 4.212 in. x 4.882 in. · Displacement: 409 cu. in liters · Air inlet heater: 24 volt preheat · Air cleaner: Dry type, replaceable element · Oil filter: Full flow with replaceable element · Fuel filter: Full flow with replaceable element · Fuel tank: 79.2 gallons, right side of carrier · Cooling: Liquid pressurized, recirculating by-pass · Radiator: Fin and tube core, thermostat controlled · Fan: Suction type, 9-blade, 28 in. diameter · Starting: 24 volt · Charging: 24 volt system, negative ground · Battery: 2-120 amp. hour · Compressor, air: 17.0 cfm @ 2,400 rpm · Output, max.: Gross 270 HP (201 kW) @ 2,000 rpm · Torque, max.: 730 ft-lb (990 Nm) @ 1,500 rpm · Capacity: Cooling water 2.7 gallons, lubrication 4.0 gallons, fuel 79.2 gallons, DEF/AdBlue 10.0 gallons.
Transmission	Electronically controlled full automatic transmission. Torque converter driving full powershift with driving axle selector. 5 forward and 2 reverse speeds, constant mesh. 2 speeds - high range - 2 wheel drive; 4 wheel drive. 3 speeds - low range - 4 wheel drive.
Travel speed	12 mph.
Gradeability	84% (at stall), 57% machine should be operated within the limit of engine crankcase design (30°: Cummins B6.7 EPA Tier4 Final).
Axle	Front: Full floating type, steering and driving axle with planetary reduction. Rear: Full floating type, steering and driving axle with planetary reduction and non-spin rear differential.
Steering	Hydraulic power steering controlled by steering wheel. Four steering modes available: 2 wheel front, 2 wheel rear, 4 wheel coordinated and 4 wheel crab.
Suspension	Front: Rigid mounted to frame. Rear: Pivot mounted with hydraulic lockout device.
Brake systems	Service: Air over hydraulic disc brakes on all 4 wheels. Parking/Emergency: Spring applied-air released brake acting on input shaft of front axle. Auxiliary: Electro-pneumatic operated exhaust brake.
Tires	29.5-25 34PR (OR) - air pressure: 57 psi.
Outriggers	Four hydraulic, beam and jack outriggers. Vertical jack cylinders equipped with integral holding valve. Each outrigger beam and jack is controlled independently from cab. Beams extend to 23' 11-3/8" center-line and retract to within 10' 10-1/2" overall width with floats. Outrigger jack floats are attached thus eliminating the need of manually attaching and detaching them. Controls and sight bubble located in superstructure cab. Four outrigger extension lengths are provided with corresponding "RATED LIFTING CAPACITIES" for crane duty in confined areas. Min. extension: 8' 10-1/4" center to center Mid. extension: 18' 1/2" center to center Mid. extension: 21' 11-3/4" center to center Max. extension: 23' 11-3/8" center to center Float size (diameter): 1' 11-5/8"

Technical Description

Standard equipment

Six section extended boom by single telescoping cylinder	39.4' - 183.7'
Bi-fold lattice jib	33.2' or 58.1' with 3.5°, 25° or 45° pinned offsets and self stowing pins.
Quick reeving type bi-fold jib	
Anti-two block device	Overwind cutout.
Mirror	For main and auxiliary winch.
Work lights	
Variable speed main winch	With grooved drum, cable follower and 771' of 3/4" cable.
Variable speed auxiliary winch	With grooved drum, cable follower and 518' of 3/4" cable.
Drum rotation indicator	Audible, visible and thumper type - main and auxiliary winch.
Auxiliary lifting sheave	Single top, stowable.
2-speed winch	
Tadano twin slewing system and 360° positive slewing lock	
Positive control	
Hydraulic oil cooler	
15° tilt cab	
3 way adjustable cloth seat	With armrests, high back and seat belt.
Tilt-telescoping steering wheel	
Tinted safety glass and sun visor	
Front windshield wiper and washer	
Roof window wiper and washer	
Power window	Cab door.
Cigarette lighter and ashtray	
Cab floor mat	
Pump disconnect in operator's cab	
Air conditioner	Hot water heater and cooler.
Full instrumentation package	
Self centering finger control levers	With pilot control.
Control pedals	For boom elevating and boom telescoping.
Warning device (visual)	Low oil pressure / high water temperature.
Rear steer centering light	
Air cleaner dust indicator	
Tadano electronic load moment indicator system (AML-C)	
Tare function	
Boom angle indicator	
Outrigger extension length detector	
Electronic crane monitoring system	
Rear view mirrors	Right and left side.
Fenders	
Air dryer	
Complete highway light package	

Technical Description

Standard equipment

Towing hooks	Front and rear.
Hook block tie down	Front bumper.
Weighted hook storage compartment	
Halogen head lamp	
Independently controlled outriggers	
Four outrigger extension positions	
Self-storing outrigger pads	
Electronic controlled automatic transmission driven by torque converter	
Drive / steer	4 x 4 x 4.
Non-spin rear differential	
Automatic rear axle oscillation lockout system	
Tires	29.5-25 34 PR.
Disc brakes	
Water separator with filter	High filtration.
Back-up alarm	
24 volt electric system	
Tool storage compartment	
Tire inflation kit	
Engine	Cummins QS 6.7 turbo charged after cooled engine (270 HP) with exhaust brake.
Engine over-run alarm	
Lifting eyes	
Telematics	Machine data logging and monitoring system with HELLO-NET via internet (availability depends on countries).
Fuel consumption monitor	
Eco mode system	
Self-removable counterweight	
Hook	7.9 ton - Weighted hook with swivel and safety latch.
Radiator cover	

Optional equipment

Working lamp	With remote controller.
Boom and jib mounted aircraft warning light	
Wind speed indicator	
Emergency steering system	
Over-unwinding prevention	
Engine oil pan heater	
Engine coolant heater	
Hook block	50 ton - 3 sheaves with hook block and safety latch. 77 ton - 5 sheaves with hook block and safety latch. 120 ton - 8 sheaves with hook block and safety latch.

tac.sales@tadano.com
www.tadano.com

Tadano Ltd.

Kanda Square 18th Floor, 2-2-1 Kanda-Nishikicho, Chiyoda-ku, Tokyo 101-0054, Japan
Phone: +81-3-6811-7309 (International Division)

Tadano America Corporation

4242 West Greens Road, Houston, TX 77066
Phone: +1 (281) 869-00300 · Fax: +1 (281) 869-0040



Reaching new heights

