



PM 48529 SP

elevate to the highest power



Grandi performance, elevato livello di affidabilità;
rotazione continua per una elevata efficienza operativa;
incremento della produttività, risparmio di tempo.

Great performance, high reliability level;
continuous rotation for high operative efficiency;
increased productivity, time saving.



DATI TECNICI

TECHNICAL DATA

MOMENTO DI SOLLEVAMENTO MASSIMO	MAXIMUM LIFTING MOMENT	39,0 TM
SBRACCIO OLEODINAMICO	HYDRAULIC OUTREACH	
Orizzontale	Horizontal	22,60 m
Verticale	Vertical	26,45 m
IMPIANTO OLEODINAMICO	HYDRAULIC SYSTEM	
Portata raccomandata	Recommended oil flow	80/100 l/min
Pressione massima	Max. pressure	32 MPa
Capacità del serbatoio	Tank capacity	200 l
GRUPPO DI ROTAZIONE	SLEWING SYSTEM	
Angolo di rotazione	Slewing angle	Cont.
Coppia di rotazione	Slewing torque	44,0 kNm
STABILIZZAZIONE	STABILIZATION	
Estensioni disponibili	Spread available	6,6 - 8,0 m
Interlock disponibile	Interlock available	5
Comando Stabilizzatori	Stabilizer control	Radio Wireless
PESO DELLA GRU STANDARD	STANDARD CRANE WEIGHT	
Con serbatoio non rifornito	With empty tank	5680 kg

Dati tecnici, descrizioni e illustrazioni sono indicativi e non impegnativi. PM Oil&Steel SpA si riserva il diritto di modificarli senza preavviso. All technical data, descriptions and illustrations are purely indicative and subject to change at PM Oil&Steel own discretion and without notice.

INGOMBRI MACCHINA BASE **DIMENSIONS**

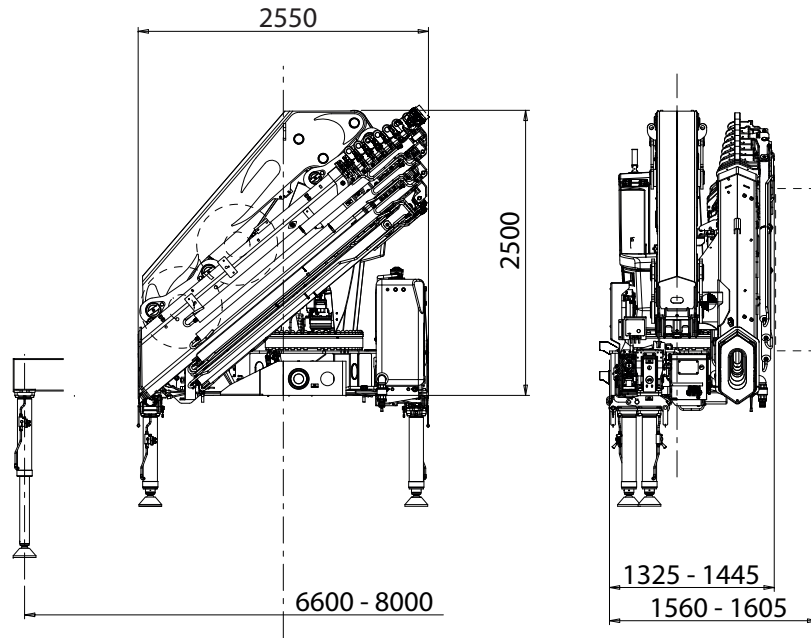

PORTATE MACCHINA BASE **LIFTING CAPACITIES**

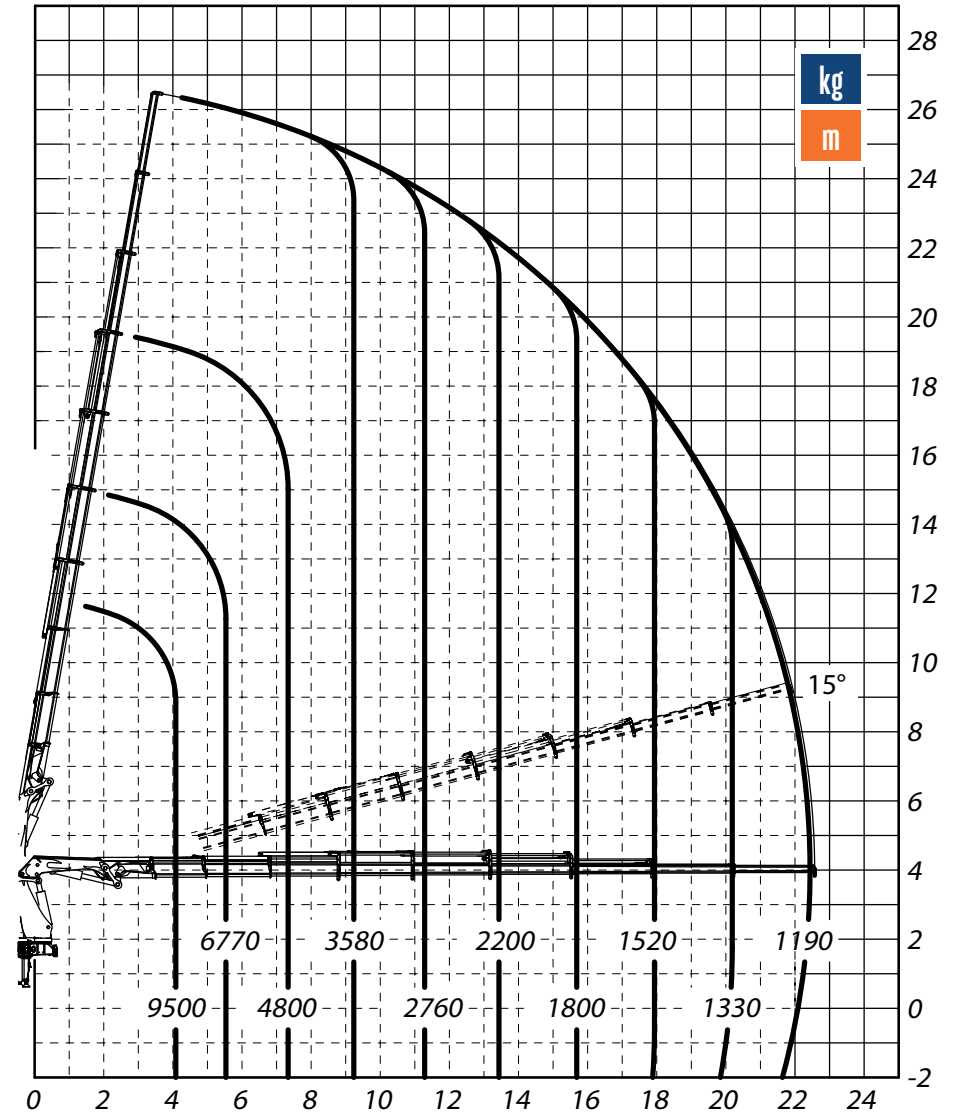
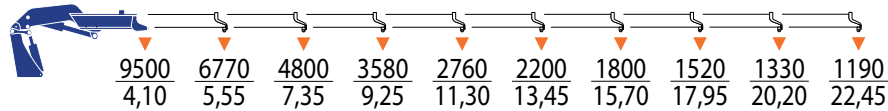

truck mounted cranes

PM OIL & STEEL S.P.A. Via G. Verdi 22, 41018 - San Cesario sul Panaro (Modena) – Italy www.pm-group.eu